

With Key

# Technical English 2

Workbook



PEARSON  
Longman

Christopher Jacques

With Audio CD

# Technical English 2

Workbook



PEARSON  
Longman

Christopher Jacques

## Pearson Education Limited

Edinburgh Gate  
Harlow  
Essex CM20 2JE  
England

and Associated Companies throughout the world.

[www.pearsonlongman.com](http://www.pearsonlongman.com)

© Pearson Education Limited 2008

The right of Christopher Jacques to be identified as author of this Work has been asserted by him in accordance with the Copyright, Designs and Patents Act 1988.

All rights reserved; no part of this publication may be reproduced, stored in a retrieval system, or transmitted in any form or by any means, electronic, mechanical, photocopying, recording, or otherwise without the prior written permission of the Publishers

First published 2008

ISBN-13: 978-1-4058-4557-1 (book)

ISBN-13: 978-1-4058-9654-2 (book for pack)

Set in Adobe Type Library fonts

Printed in Spain by Graficas Estella

## Acknowledgements

We would like to dedicate this book to the memory of David Riley, whose tireless professionalism contributed so much to its creation and success.

The publishers and author would like to thank the following for their invaluable feedback, comments and suggestions, all of which played an important part in the development of the course: Eleanor Kenny (College of the North Atlantic, Qatar), Julian Collinson, Daniel Zeytoun Millie and Terry Sutcliffe (all from the Higher Colleges of Technology, UAE), Dr Saleh Al-Busaidi (Sultan Qaboos University, Oman), Francis McNeice, (IFOROP, France), Michaela Müller (Germany), Małgorzata Ossowska-Neumann (Gdynia Maritime University, Poland), Gordon Kite (British Council, Italy), Wolfgang Ridder (VHS der Stadt Bielefeld, Germany), Stella Jehanno (Centre d'Etude des Langues/ Centre de Formation Supérieure d'Apprentis, Chambre de Commerce et d'Industrie de l'Indre, France) and Nick Jones (Germany).

Illustrated by HL Studios

The publisher would like to thank the following for their kind permission to reproduce their photographs:

(Key: b-bottom; c-centre; l-left; r-right; t-top)

**Alamy Images:** Dex Images 50; Kenslens 49bl; Martin Jenkinson 46; Niall Cotton 54; Rene Paik 49tl; Sandra Baker 25tc; **Art Directors and TRIP photo Library:** Helene Rogers 14; **Combisafe International Ltd:** Combisafe International Ltd 9; Corbis: Arcaid 25tr; Car Culture 12; David Woods 45; Massimo Listri 16; Neil Rabinowitz 62; Onne van der Wal 15; Patrice Latron 4; Skyscan 49b; Wolfran Schroll/Zefa 49c; Yuriko Nakao/Reuters 49t; **iStockphoto:** 25; David Pedre 25tl; Stena Ferries: Stena Ferries 56

Cover image: *Front:* iStock Photo: Kristian Stensoenes

All other images © Pearson Education

Picture Research by: Alison Prior

Every effort has been made to trace the copyright holders and we apologise in advance for any unintentional omissions. We would be pleased to insert the appropriate acknowledgement in any subsequent edition of this publication.

Designed by HL Studios, Long Hanborough

Cover design by Designers Collective

Project managed by David Riley

# Contents

- Unit 1 Action**
- 4 **1.1 Teamwork**  
Maintenance equipment  
Giving instructions  
Describing a series of actions  
Imperatives  
Present simple
- 5 **1.2 Training**  
Reporting jobs in progress/completed  
Present continuous and present perfect  
*Just a minute, Hang on.*
- 6 **1.3 Method**  
Describing how things work  
Asking questions about a robot  
Method: by + gerund
- Unit 2 Work**
- 8 **2.1 Routines**  
Describing routines and current actions  
Talking about an organisation chart  
Present simple and present continuous
- 9 **2.2 Plans**  
Stating plans and intentions  
Formulae in emails  
Future: Present continuous and *going to*
- 10 **2.3 New job**  
Reading and updating a CV  
Revision of tenses  
Word stress
- 12 **Review Unit A**
- Unit 3 Comparison**
- 14 **3.1 Limits**  
Explaining dimension limits  
Comparative adjectives  
Revision: *4m wide; a width of 4m*
- 15 **3.2 Products**  
Asking, offering and checking  
Specifying requirements  
Modals: *would, could, shall*  
Pronouns: *one, ones, Which one?*
- 16 **3.3 Equipment**  
Comparing three or more items  
Comparatives and superlatives  
*the -est of; the most/least + adjective*
- Unit 4 Processes**
- 18 **4.1 Infrastructure**  
Talking about an infrastructure project  
Describing a process  
*Present simple passive + linkers: first*
- 19 **4.2 Manufacturing**  
Describing a manufacturing process  
*Present simple passive + linkers: simultaneously*
- 20 **4.3 Communications**  
Description of a communications satellite  
Narrating events in space exploration  
Relative clauses (non-defining): *which, who*
- 22 **Review Unit B**
- Unit 5 Descriptions**
- 24 **5.1 Uses**  
Describing uses or functions of common objects  
Gerund: *(used) for + verb + -ing*  
Infinitive: *(designed) to + infinitive*  
*act as + noun: it acts as a propeller*
- 25 **5.2 Appearance**  
Describing the shape and appearances of buildings  
*In the shape of two-/three-dimensional adjectives: circular, conical*
- 26 **5.3 Definitions**  
Giving a definition  
Defining relative clauses + *who/which/that*  
Type nouns: *device, system*
- Unit 6 Procedures**
- 28 **6.1 Safety**  
Describing safety hazards, regulations and procedures  
Modals + passive: *must be removed*
- 29 **6.2 Emergency**  
Recommending emergency action  
Describing necessity  
Revision of zero conditional  
Modals + passive: *should be freed they/them/their/theirs*
- 30 **6.3 Directions**  
Following and giving directions  
Direction phrases: *Go straight ahead.*
- 32 **Review Unit C**
- Unit 7 Services**
- 34 **7.1 Technical support**  
Diagnosing causes  
Suggesting solutions  
Talking about certainty and possibility  
Certainty/possibility: *You must/may have checked ...*  
Suggestions: *Try doing ...*
- 35 **7.2 Reporting to clients**  
Reporting on work done  
Laying out a business letter  
Past simple passive: *A lift was installed*  
Revision: *expressing purpose + to*
- 36 **7.3 Dealing with complaints**  
Sympathising, apologising, offering a solution  
Reporting damage/faults  
Describing damage: *bent, crushed, cracked*  
Formulae in letters: *Please do not hesitate ...*
- Unit 8 Energy**
- 38 **8.1 Wave power**  
Describing movement and motion  
Presenting technical information orally  
rotary, linear ...
- 39 **8.2 Engines**  
Describing the operation of an engine  
Describing a hybrid car  
Reference and cohesion: *which* referring to a phrase
- 40 **8.3 Cooling and heating**  
Noun families: *reactor/reaction*  
Describing a flow cycle  
Revision of physical changes: *melt, freeze*
- 42 **Review Unit D**
- Unit 9 Measurement**
- 44 **9.1 Sports data**  
Describing the purpose of measuring instruments  
Using a service schedule  
*A thermometer measures temperature/is used for measuring temperature*  
Describing frequency: *every 24 months*
- 45 **9.2 Sensors**  
Talking about safety data for cars  
Explaining forces  
Safety ratings: *marginal, acceptable*  
Forces: *bending forces*
- 46 **9.3 Positioning**  
Explaining a lidar speed gun  
Describing a radar control system  
Indirect *Wh-* questions: *how fast they are flying*  
Discourse markers: *In other words*
- Unit 10 Forces**
- 48 **10.1 Properties**  
Stating objectives  
Describing properties of materials  
Indirect *Yes/No* questions: *The aim is to find out if the plastic bends.*
- 49 **10.2 Resistance**  
Resistance to forces  
Marking stages of a presentation  
Property suffixes: *-able*  
Discourse markers: *Let's move on to*
- 50 **10.3 Results**  
Explaining results  
Describing a manufacturing process  
Result markers: *therefore*  
Causative verbs: *harden*
- 52 **Review Unit E**
- Unit 11 Design**
- 54 **11.1 Working robots**  
Describing robots in industry  
Robotics terms: *'teach-and-repeat'*
- 55 **11.2 Eco-friendly planes**  
Describing aeronautics  
Describing an aeronautical project  
Cause and effect + present simple  
Needs analysis + *too/enough*
- 56 **11.3 Free-flying sails**  
Marking stages of a presentation  
Advantages and disadvantages  
Discourse markers: *The aim of this talk is to ...*  
Formulae and questions in a presentation
- Unit 12 Innovation**
- 58 **12.1 Zero emission**  
Explaining needs, problems and solutions  
Reduced relative clause: *part of the power produced by the engine*
- 59 **12.2 Technological change**  
Describing simple machines  
Describing a historical process  
Defining relative clauses + *that, which*
- 60 **12.3 Vehicle safety**  
Describing safety systems and sensors  
Present simple active
- 62 **Review Unit F**
- 64 **Audioscript**
- 70 **Answer key**

## 1 Teamwork

- 1 Look at the pictures and complete the crossword puzzle. What is the vertical word?

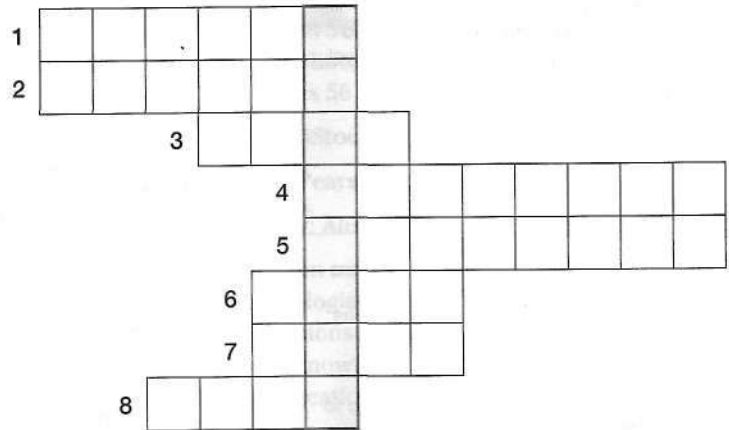
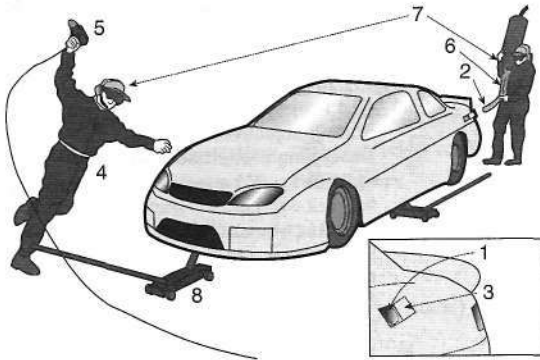

- 2 Number the steps for refuelling a plane in the best order.

- Switch on the pump.
- Push the nozzle into the fuel socket.
- 1 Drive the fuel tanker to the plane.
- Pump fuel into the plane's fuel tanks.
- Clean any spilled fuel off the plane.
- Switch off the pump.
- Close the fuel flap.
- Remove the fuel nozzle.
- Open the fuel flap under the wing.



- 3 Give these sentences the opposite meaning. Use words from 2, Section 1 on Course Book pages 4-5.

- |   |                                    |                                       |
|---|------------------------------------|---------------------------------------|
| 1 | The car enters the pit lane.       | 1 <i>The car leaves the pit lane.</i> |
| 2 | The driver opens the fuel flap.    | 2 _____                               |
| 3 | They loosen the wheel nuts.        | 3 _____                               |
| 4 | They raise the car off the ground. | 4 _____                               |
| 5 | Someone switches on the fuel pump. | 5 _____                               |
| 6 | They take off the old wheels.      | 6 _____                               |
| 7 | They take away the old wheels.     | 7 _____                               |

## 2 Training

- 1 A trainee is phoning the company technician. He needs to change the ink cartridges on his printer. Complete the dialogue.

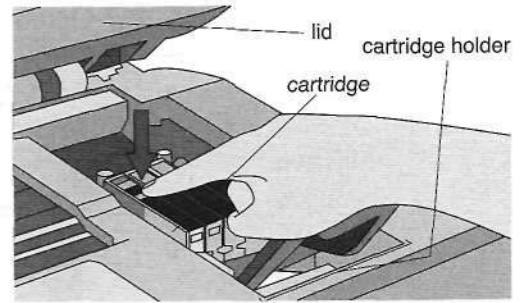

- A: Switch on the printer.  
 B: *I've switched it on.*  
 A: Now lift up the lid.  
 B: *I'm lifting it up now.*  
 A: Take out the old cartridges.  
 B: I've \_\_\_\_\_ them \_\_\_\_\_.  
 A: Now put in the new cartridges.  
 B: I'm \_\_\_\_\_ them \_\_\_\_\_ now.  
 A: Push the cartridges in firmly.  
 B: I've \_\_\_\_\_ them \_\_\_\_\_.  
 A: Now put down the lid and press 'Return'.  
 B: I've \_\_\_\_\_ 'Return'.  
 A: Now wait. The printer will now do the ink charging.  
 B: I'm \_\_\_\_\_. I'm still \_\_\_\_\_! Ah! I think it's finished.  
 A: Good! Now you can \_\_\_\_\_ off the printer, or print a document.

- 2 Write dialogues between a supervisor (S) and some trainees (T). Use the words in brackets and the checklists below.

1 S: (how / get on?) *How are you getting on?*

T: (minute / alarm) *Just a minute. I've taken apart the alarm.*

S: (check / yet?) *Good. Have you \_\_\_\_\_?*

T: (not yet / do). *No, not yet. I'm still \_\_\_\_\_*

2 S: (how / work / go?) *How is the work going?*

T: (hang / still / clean) \_\_\_\_\_

S: (put / yet) \_\_\_\_\_

T: (yes / them) \_\_\_\_\_

3 S: (how / get on?) \_\_\_\_\_

T: (minute / handles) \_\_\_\_\_

S: (paint / yet?) \_\_\_\_\_

T: (still / almost) \_\_\_\_\_

4 S: (how / work / go?) \_\_\_\_\_

T: (still / almost) \_\_\_\_\_

S: (install / yet?) \_\_\_\_\_

T: (not yet / next) \_\_\_\_\_

Electrician	Mechanic	Painter	Computer technician
<input checked="" type="checkbox"/> take apart alarm	<input type="checkbox"/> clean spark plugs	<input checked="" type="checkbox"/> take off handles	<input type="checkbox"/> fit new hard disk
<input type="checkbox"/> check the wiring	<input checked="" type="checkbox"/> put on new tyres	<input type="checkbox"/> paint the doors	<input type="checkbox"/> install memory card

### 3 Method

1  Listen to six dialogues. Write the dialogue number next to the device.

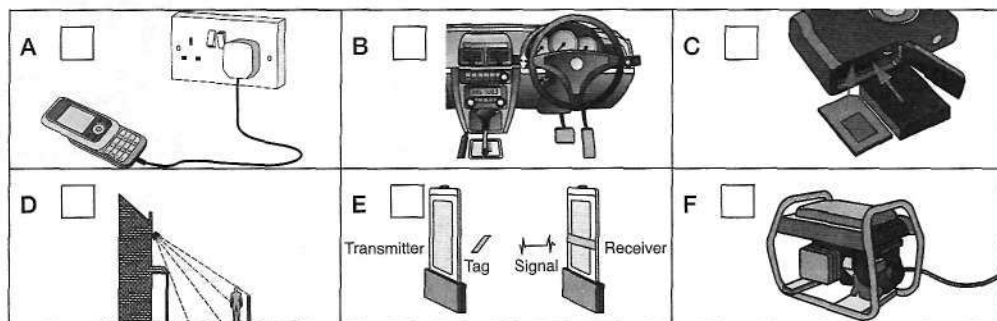

2  Complete the explanations about the devices in 1. Use the verbs from the box. Then listen and check your answers.

activate activate attach carry deactivate pass plug press press protect  
start start start switch turn turn

- You *start* the motor by *pressing* this button.
- A person coming near the house \_\_\_\_\_ on the light by \_\_\_\_\_ the motion sensor.
- You \_\_\_\_\_ it on by \_\_\_\_\_ this button.
- The driver \_\_\_\_\_ the engine by \_\_\_\_\_ the key in the lock.
- You \_\_\_\_\_ the charging process by \_\_\_\_\_ in the adapter and switching it on.
- The store \_\_\_\_\_ goods by \_\_\_\_\_ a magnetic strip to them.
- The sales person \_\_\_\_\_ the strips by \_\_\_\_\_ them over a scanner.
- A thief will \_\_\_\_\_ the alarm by \_\_\_\_\_ unsold goods between the transmitter and receiver.

3 Read the text about the robot in 8, Section 3 of the Course Book, page 9. Write questions for this interview with the inventor of the robot.

- A: *How much* \_\_\_\_\_?  
B: It weighs less than 5 kilos.
- A: *How* \_\_\_\_\_?  
B: It's only 508 mm tall.
- A: \_\_\_\_\_?  
B: By means of a sensor in its body.
- A: \_\_\_\_\_?  
B: The camera.
- A: \_\_\_\_\_?  
B: It's in the robot's head.
- A: \_\_\_\_\_?  
B: By using a computer.
- A: \_\_\_\_\_?  
B: By means of a wireless receiver.
- A: \_\_\_\_\_?  
B: It's in the box on its back.

## 4 Word list

NOUNS (car)	NOUNS	VERBS	PHRASAL VERBS
accelerator	camera	activate	lift up
air pressure	chest	adjust	pick up
blanket	cord	break	pull out
cockpit	device	detect	push in
driver	dial	insert	put down
emergency stop	fault	kick	put on
fire suit	handset	locate	put together
flap	iPod	lower	strip off
front	laser beam	pump	switch off
fuel	outboard motor	raise	switch on
gear lever	plaster hole	repair	take apart
hose	receiver	replace	take away
mechanic	robot	service	take off
nozzle	sensor	signal	take out
passenger	surface	spill	turn off
pit lane	technology	test	turn on
pit-stop crew	ticket machine	touch	<b>ADVERBS</b>
rear	water heater	<b>TIME PHRASES</b>	ahead
socket	water valve	almost done	away
trainee	wireless	hang on	forward
tyre		immediately	sideways
visor		just a minute	upright
wheel-gun		nearly finished	
wheel-jack		one minute	

- 1 Tick the words and phrases that you remember from Workbook 1. Study the others.
- 2 Complete the sentences with nouns from the Word list. Some alternatives are possible.
  - 1 Loosen the nuts with the \_\_\_\_\_.
  - 2 Raise the \_\_\_\_\_ of the car with the wheel-jack.
  - 3 Adjust the \_\_\_\_\_ in the tyres.
  - 4 Pull the cord on the \_\_\_\_\_ to start the engine.
  - 5 If you see an accident ahead, press the brake and do an \_\_\_\_\_.
  - 6 Push down the \_\_\_\_\_ with your right foot.
  - 7 Clean the \_\_\_\_\_ on the driver's helmet with a cloth.
  - 8 If you need hot water, turn on the \_\_\_\_\_.
  - 9 Tighten the safety belt across your \_\_\_\_\_.



## 1 Routines

- Find these things in the pictures.
  - crane
  - underwater pipe
  - fire drill
- Write questions and answers about these people. What are they doing today? What do they usually do?

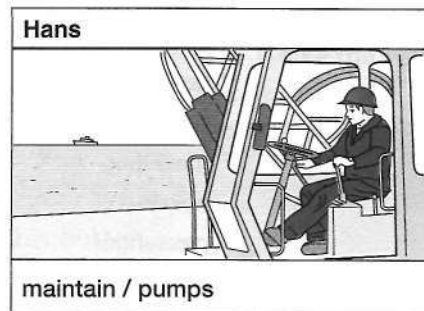
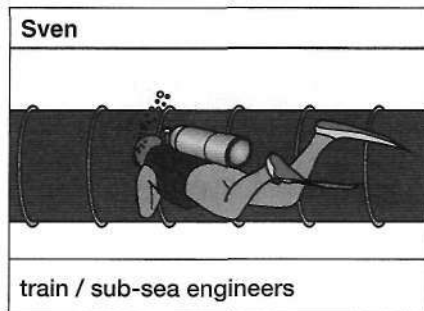

- What is Sven doing today?  
He is repairing an underwater pipe.
- What does Sven usually do?  
He trains sub-sea engineers.
- What is Hans doing today?  
\_\_\_\_\_
- What does Hans usually do?  
\_\_\_\_\_
- What is Eric doing today?  
\_\_\_\_\_
- \_\_\_\_\_?  
He checks the electrical equipment.

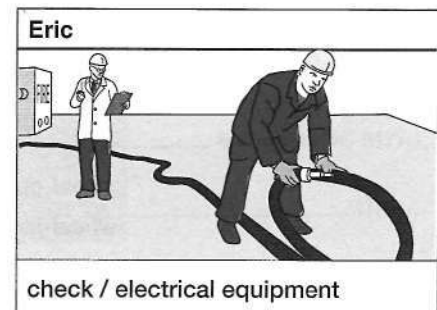

- Look at the organisation chart and answer the questions.

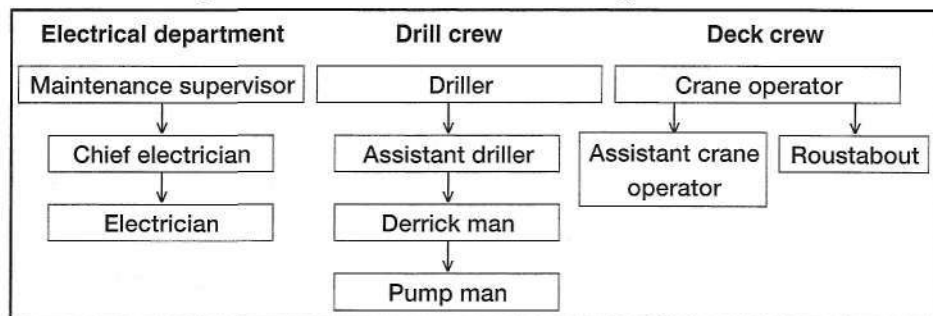

- Who reports to the Chief Electrician? *The Electrician.*
- Who does the Chief Electrician report to? *The Maintenance Supervisor.*
- Who reports to the Assistant Driller? \_\_\_\_\_
- Who does the Roustabout report to? \_\_\_\_\_
- Who does the Pump Man report to? \_\_\_\_\_
- Who does the Assistant Driller report to? \_\_\_\_\_
- Who reports to the Crane Operator? \_\_\_\_\_

## 2 Plans

- 1 Complete the dialogue using the verbs in brackets.  
Two crew members on land are talking on the phone.

A: Have you heard the news? A maintenance team (1 go) *is going* out to the platform next Monday.

B: What (2 do) *are they going to do*? They can't do any drilling

A: They (3 inspect) \_\_\_\_\_ the fire damage.

B: Who (4 go) \_\_\_\_\_?

A: All the supervisors and the maintenance supervisor.

B: How long (5 stay) \_\_\_\_\_ on the platform?

A: They (6 want / finish) \_\_\_\_\_ by the end of the week. They (7 need / inspect)

\_\_\_\_\_ all the machinery and check all the electrical systems.

B: Then what?

A: They (8 intend / come) \_\_\_\_\_ back and present their report. If all goes well, they (9 hope / start) \_\_\_\_\_ repairs one or two weeks later.

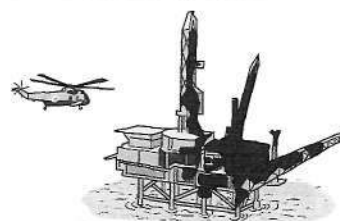
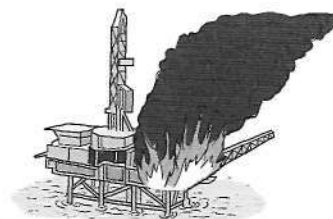

- 2 Read the email from the Maintenance Supervisor. What does the company need to buy for repairs to the oil platform?

Delete   Junk   Reply   Reply All   Forward   Print

To: Jay Reed, Safety Officer  
From: Peter Boyle, Maintenance Supervisor  
Subject: Repairs to Beta 2 Platform

Hi Jay,  
Following our site visit, please investigate and find some suppliers for the products below. Please email the product information to me before our meeting on Friday.

1 We need to buy some steel mesh barriers for the repair work. This will stop waste and tools from falling onto workers below.  
*> found company; supplies a good product; attach pages from their website; is this system suitable?*

2 We need to buy some lightweight safety nets. This will prevent serious accidents to personnel when working at height. As the structure is damaged, we must make sure the repair crew can work safely.  
*> same company also supplies and fits safety nets; important to fit these correctly; do you need prices before Friday?*

Regards, Peter



- 3 Use Jay's notes from 2 to send an email reply from Jay to Peter. Use all the phrases from the box.

As you are aware / Regards / Do let me know if / With reference to / Could you please / I confirm that / Thanks for / I attach

Example: *Dear Peter,*

*Thanks for ...*

*With reference to ...*

### 3 New job

- 1  04 Read part of a CV, then listen to the interview. Complete the missing sections and update some of the information.

Curriculum Vitae	
<b>Personal information</b>	
Surname / First name(s)	Muti, Laura _____
Desired employment	(1) <i>Computer technician</i> (2) _____
<b>Work experience</b>	
Dates	From _____ to _____
Occupation or position held	<i>Computer technician</i>
Main activities and responsibilities	<i>Do computer upgrades; install software, memory cards, anti-virus systems, etc.</i> Do _____
Name and address of employer	<i>Wiggins Support Unit 12 Delly End Industrial Estate Windsor</i>
Type of business or sector	<i>Information Technology</i>
Reason for leaving present/last employer	<i>Wants to move to Swindon</i> _____

- 2  05 Listen and write the questions.

- 1 \_\_\_\_\_
- 2 \_\_\_\_\_
- 3 \_\_\_\_\_
- 4 \_\_\_\_\_

- 3  06 Write the words from the box on the correct lines. Then listen and repeat.

electrical electrician electricity electron engine engineer mechanical  
mechanism occupation operator technical technician

- 1 1st syllable stressed: \_\_\_\_\_
- 2 2nd syllable stressed: *electrical* \_\_\_\_\_
- 3 3rd syllable stressed: \_\_\_\_\_

## 4 Word list

NOUNS (oil rig)	NOUNS	VERBS	ADJECTIVES
accident rate	casualty	appreciate	available
blowout preventer	catalogue	attach	aware
control room	conference	attend	electronic
deck	electron	confirm	fantastic
derrick	electronics	hesitate	grateful
emergency escape	engineering	inspect	heat-resistant
equipment	maintenance	intend	mechanical
heat shield	mechanics	introduce	technical
ladder	mechanism	maintain	underwater
oil platform	sick leave	operate	<b>ADVERBS</b>
rig	technology	plan	on duty
safety drill	<b>(new job)</b>	report	off duty
<b>(jobs)</b>	activity	request	onshore
crane operator	business sector	run (= conduct)	offshore
driller	CV	supervise	on leave
electrician	diploma	train	
engineer	employment		
participant	experience		
roustabout	job title		
safety officer	occupation		
site manager	position		
supervisor	qualification		
technologist	responsibility		
witness			

1 Find the best person for the activity. Choose jobs from column 1.

- 1 *Crane operators* operate the cranes.
- 2 \_\_\_\_\_ repair electrical faults.
- 3 \_\_\_\_\_ operate the drilling equipment.
- 4 \_\_\_\_\_ maintain and repair the pipes.
- 5 \_\_\_\_\_ conduct fire drills.
- 6 \_\_\_\_\_ plan all the work on their platforms.
- 7 \_\_\_\_\_ move heavy objects around the platform.

## Section 1

1 Describe the pictures using the verbs in the box.

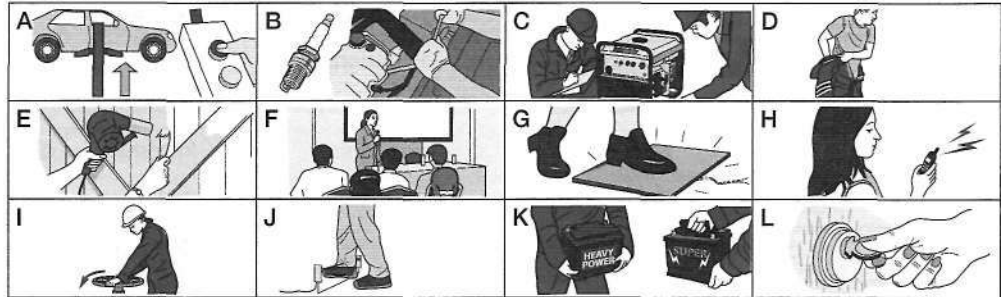

activate carry examine insert put raise receive replace rotate run  
step strip

- 1 He's *replacing* the spark plugs. *B*
- 2 They're *carrying* some batteries. *K*
- 3 She \_\_\_\_\_ the wheel.
- 4 They \_\_\_\_\_ the generator.
- 5 She \_\_\_\_\_ off the old paint.
- 6 He \_\_\_\_\_ the alarm.
- 7 She \_\_\_\_\_ a key.
- 8 She \_\_\_\_\_ a training course.
- 9 He \_\_\_\_\_ the car.
- 10 She \_\_\_\_\_ on the alarm pad.
- 11 He \_\_\_\_\_ on a fire suit.
- 12 She \_\_\_\_\_ a mobile signal.

2 Find pairs of verbs that mean the opposite. Join them with a line.

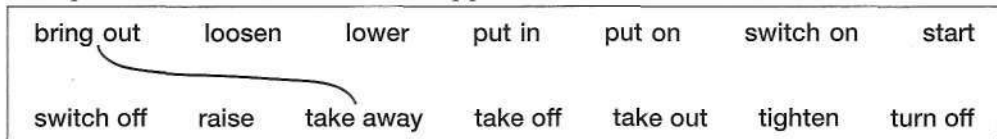

3 Give instructions for changing a set of spark plugs. Use verbs from Exercise 2.

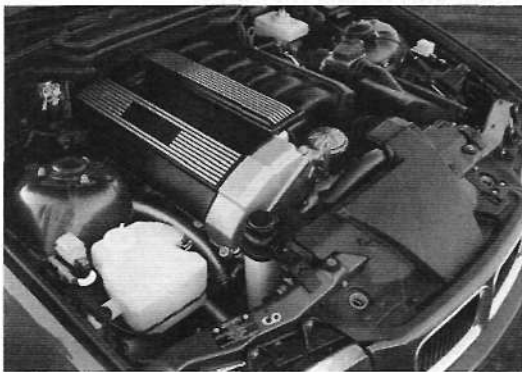

- 1 Drive the car into the garage and *turn off* the engine.
- 2 \_\_\_\_\_ the bonnet of the car.
- 3 \_\_\_\_\_ the first lead.
- 4 \_\_\_\_\_ the old spark plug with a box spanner.
- 5 \_\_\_\_\_ the old spark plug.
- 6 \_\_\_\_\_ a new spark plug.
- 7 \_\_\_\_\_ the new spark plug with a box spanner.
- 8 \_\_\_\_\_ the first lead. Repeat steps 3–8 with the other spark plugs.
- 9 \_\_\_\_\_ the car bonnet.
- 10 \_\_\_\_\_ the engine and drive out of the garage.

## Section 2

- 1 Read the article. Replace the numbered words and phrases with a word or phrase from 2, Section 3 of the Course Book, page 14.

- 1 *position*
- 2 C \_\_\_\_\_
- 3 p \_\_\_\_\_ i \_\_\_\_\_
- 4 e \_\_\_\_\_
- 5 q \_\_\_\_\_
- 6 t \_\_\_\_\_
- 7 b \_\_\_\_\_ s \_\_\_\_\_
- 8 s \_\_\_\_\_
- 9 w \_\_\_\_\_ e \_\_\_\_\_
- 10 j \_\_\_\_\_ t \_\_\_\_\_
- 11 j \_\_\_\_\_ d \_\_\_\_\_
- 12 i \_\_\_\_\_
- 13 e \_\_\_\_\_
- 14 a \_\_\_\_\_
- 15 r \_\_\_\_\_

### Looking for a New Job

When you are looking for a new (1) **job**, you must prepare a (2) **document** that you can send to possible companies. This contains (3) **details about yourself**, also your (4) **schools and colleges that you attended**.

A company first needs to check whether you have the right (5) **certificates** and whether you spent time (6) **learning how to do the job** after college. Preferably, you are already working in the same (7) **area of work**. It also wants to know about your (8) **abilities** – for example, do you speak a foreign language, and can you use a computer?

A company will study the record of your (9) **work that you have done**. For your present job, you must give the (10) **exact name**, and a (11) **description of it**. If the company asks you to attend a (12) **meeting**, be prepared to answer questions about your present (13) **company** and your (14) **work that you do**. Mention if you supervise any staff, because employers appreciate people with these kinds of (15) **duties**.

- 2 Complete the body of this email with phrases from the box.

This is also to let you know that / Do let me know if / I'd like to confirm that / Kind regards / Fortunately / Thanks for / I would appreciate it if you could / As you may know / I attach / I am sorry to tell you that / With regard to /

- (1) \_\_\_\_\_ your email. (2) \_\_\_\_\_ the Safety Conference next week, (3) \_\_\_\_\_ I plan to attend. Sorry for the short notice.  
(4) \_\_\_\_\_ the PowerPoint slides that you requested.  
(5) \_\_\_\_\_ I'll email you the Executive Summary by Friday at the latest.

- (6) \_\_\_\_\_, Marco Burgos has been ill for the past month.  
(7) \_\_\_\_\_ he is going into hospital for an operation.  
(8) \_\_\_\_\_, his deputy, Pedro Granada, will take part in the Forum instead. (9) \_\_\_\_\_ forward this email to the person responsible for printing the Conference Programme.

- (10) \_\_\_\_\_ you need any further information.  
(11) \_\_\_\_\_,

Kurt Brandt

## 1 Limits

1 Read the text and answer the questions.

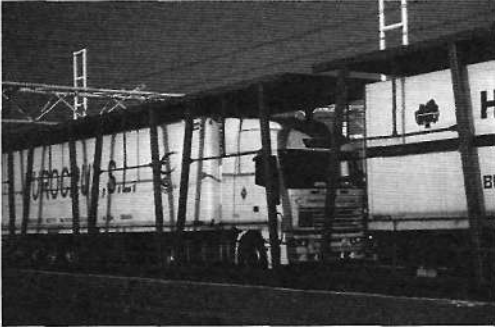

Eurotunnel Freight runs rail freight services through the Channel Tunnel. Lorries are loaded onto wagons at one terminus and unloaded at the terminus on the other side. The train journey lasts 35 minutes. At €400 for a one-way crossing, the price is higher than by ferry. Containers or unaccompanied trailers cannot be carried. Dangerous loads can be carried but not large, abnormal loads.

However, there are advantages in using the tunnel. First, the journeys are quicker and loading and unloading takes less time. Train journeys are more frequent than ferry crossings.

There are between three and six departures per hour, compared with one per hour for ferry sailings. Finally, the trains are not affected by the weather, with 94 per cent of trains departing on time. In winter, fog and high winds can cause delays or cancellations of ferry services. However, trains continue to operate below the Channel whatever the weather.

1 How long does the train journey take through the Channel Tunnel?

2 Which is more expensive, a crossing by tunnel or by ferry?

3 What kinds of loads cannot be taken through the tunnel?

4 What are two advantages of using the tunnel?

5 What is one disadvantage of using the ferry?

2 Complete the factsheet on maximum dimensions from the diagrams.

Eurotunnel freight	Ferry freight

Eurotunnel freight

1 Lorries *must not be heavier* than 44 tonnes.

2 Lorries \_\_\_\_\_ 18.75 metres.

3 Lorries \_\_\_\_\_ 4.2 metres.

4 Lorries \_\_\_\_\_ 2.6 metres.

Ferry freight

5 The *length limit* depends on the individual ferry.

6 The \_\_\_\_\_ for lorries on all ferries is 4.8 metres.

7 The \_\_\_\_\_ for lorries on all ferries is 6.7 metres.

8 The \_\_\_\_\_ for standard lorries is 44 tonnes.

## 2 Products

### 1 Match the words to the questions about ePhones.

- |                 |   |
|-----------------|---|
| 1 dimensions    | a) What is the diagonal distance across the screen?     |
| 2 weight        | b) How long does it take to recharge the battery fully? |
| 3 screen size   | c) How much does it weigh?                              |
| 4 capacity      | d) How long does the battery last?                      |
| 5 battery       | e) What other things are in the specification?          |
| 6 charging time | f) What are its measurements?                           |
| 7 features      | g) How many gigabytes does it have?                     |

### 2 Complete Part 1 of a phone dialogue. A customer (C) is asking a sales clerk (S) about power boats.



C: Hello. I'm interested in the Combo 150 and the Combo 200.

S: Right. (1) Would you \_\_\_\_\_  
Sales Department, or (2) \_\_\_\_\_  
a catalogue?

C: At this stage, I just need a catalogue.

S: OK. Could (3) \_\_\_\_\_?

C: Sure. It's McCredy. That's M little-C big-C R-E-D-Y. McCredy, initial B.

S: Is (4) \_\_\_\_\_ or \_\_\_\_\_?

C: B for Bravo.

S: And (5) \_\_\_\_\_?

C: The Firs, Wyatt Avenue.

S: Could (6) \_\_\_\_\_?

C: Yes, it's W-Y-A-double-T. Wyatt Avenue, Dundee, Scotland. Postcode DD3 7NU.

S: Would (7) \_\_\_\_\_?

C: DD3 7NU.

S: And could I (8) \_\_\_\_\_?

C: Sure. 01382 458222.

S: Fine. I'll get that in the post to you today.

### 3 Complete Part 2 of the dialogue. The customer (C) is placing an order. Use information from the table.

Model	ProCraft Combo 150/200	Colour	blue/yellow; red/cream
Fuel tank	50/70 litres	Trailer (extra)	€460/525

C: Hello, I'd like to order a Combo power boat. I've seen your catalogue.

S: (1) *Which one would you like to order*, the 150 or the 200?

C: (2) *The larger one*, the 200 model.

S: OK. What size fuel tank? The smaller size holds 50 litres and the larger one holds 70 litres.

C: (3) \_\_\_\_\_.

S: Which colours? We have a blue and yellow one in stock and a red and cream one.

C: (4) \_\_\_\_\_.

S: What about a trailer? We do a standard one at €460, or we do a heavier one at €525.

C: (5) \_\_\_\_\_.



### 3 Equipment

1  07 Read the quiz and circle your answers. Then listen and check.

- 1 How far away is the nearest star?  
a) 3.46    b) 4.24    c) 4.36 light years away.
- 2 How deep is the deepest part in the world's oceans?  
a) 6,742 metres    b) 8,213 metres    c) 10,911 metres
- 3 On the Mohs scale of mineral hardness, which of these materials is the hardest?  
a) silver    b) glass    c) iron
- 4 Which of these gases is the least common in the atmosphere?  
a) oxygen    b) hydrogen    c) nitrogen
- 5 What was the hottest temperature on Earth, recorded in 1922?  
a) 49° Celsius    b) 53° Celsius    c) 58° Celsius
- 6 What was the coldest temperature on earth, recorded in 1983?  
a) -78° Celsius    b) -89° Celsius    c) -97° Celsius

2  08 Listen and complete the sentences.

- 1 The nearest star \_\_\_\_\_ is called Alpha Centauri. It's \_\_\_\_\_ and can be seen from the southern hemisphere.
- 2 A \_\_\_\_\_ ship sent down an \_\_\_\_\_ probe to the deepest point on the seabed at a place called the Marianas Trench in the \_\_\_\_\_.
- 3 The Mohs scale of mineral hardness \_\_\_\_\_. It ranges from talc, which is \_\_\_\_\_ on the scale, to diamond, which is \_\_\_\_\_. Silver is \_\_\_\_\_ of the three materials and glass is \_\_\_\_\_.
- 4 The \_\_\_\_\_ of these three gases is nitrogen. Hydrogen is \_\_\_\_\_ than oxygen and is \_\_\_\_\_ of these three gases.

3 Read the headings in the specification table for four luxury yachts, then delete the wrong answers below.

NAME	COST	LENGTH	TOP SPEED	MAX GUESTS	NO. OF CREW
Alysia	\$116.7m	85.3m	33kph	36	34
Oceanco 702	\$111.8m	82m	35kph	12	28
O'Mega	\$64.1m	82.6m	30kph	32	-
Sherakhan	\$55.4m	69.8m	10kph	26	-



- 1 Sherakhan is the (*most / least*) expensive of the yachts.
- 2 Oceanco 702 is (*as expensive as / not as expensive as*) Alysia.
- 3 The second longest yacht is (*Sherakhan / O'Mega / Oceanco 702 / Alysia*).
- 4 Alysia is the (*fastest / second fastest / slowest*) of the yachts.
- 5 (*More / Fewer*) guests can stay on O'Mega than on Alysia.
- 6 There are (*fewer / more*) crew members per guest on Alysia than on Oceanco 702.

## 4 Word list

NOUNS (vehicle)	NOUNS (other)	VERBS	ADJECTIVES
4x4	catalogue	board	classic
acceleration	coin	cancel	coal-fired
cab	hire	complain	external
clearance	mode	cruise	normal
combination	nanometre	idle	portable
consumption	nanotube	tow	rapid
cruising speed	nuclear power		rechargeable
diesel	propeller		standard
dimension	purchase		unleaded
fleet	recommendation		<b>IRREGULAR COMPARATIVES AND SUPERLATIVES</b>
idle speed	strength		
luggage	tender		
performance	transistor		
petrol	weakness		
roof rack	wingspan		better
steel rim wheel	world record		best
storage capacity			worse
trailer			worst
van			farther
vehicle			farthest
wheelbase			further
			furthest
			more
			most
			less
			least

1 Label the parts of the vehicle with words from the Word list.

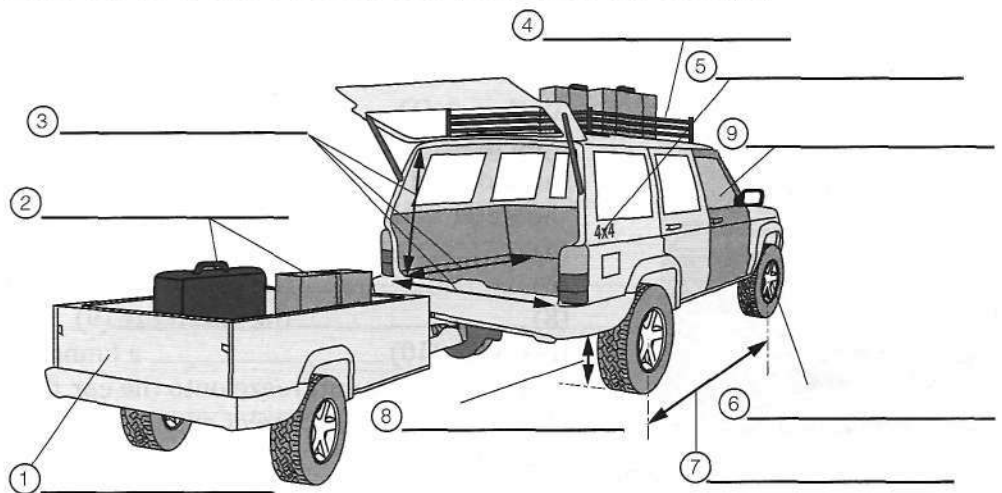

## 1 Infrastructure

- 1 09 Listen to the interview about Stage 2 of the High-Speed Rail Link. Write down the details.

Channel tunnel opens: \_\_\_\_\_  
 Rail Link Stage 1 opens: \_\_\_\_\_  
 Rail Link Stage 2 opens: \_\_\_\_\_  
 London-Paris (2002): \_\_\_\_\_ hours  
 London-Paris (2007): \_\_\_\_\_ hours  
 Stage 2 took \_\_\_\_\_ years.  
 Manpower: \_\_\_\_\_ hours  
 Number of tunnel drills used: \_\_\_\_\_  
 Cost: £ \_\_\_\_\_ @ cost per drill: £ \_\_\_\_\_  
 A train travels through \_\_\_\_\_ kms of tunnels  
 and over \_\_\_\_\_ bridges.

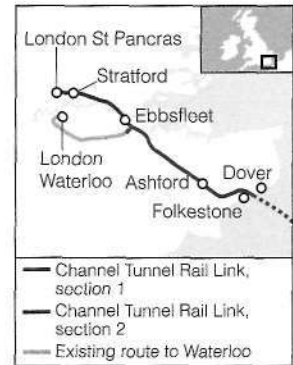

- 2 10 Listen and circle the words and phrases that you hear.

- 1 You must be very pleased with the successful completion / success and completion of the project.
- 2 The French built their high-speed link 30 months / 13 years ago and now we've just finished ours.
- 3 Eurostar / First-class trains can now travel at a speed of up to 298 kph / 148 mph.
- 4 The twin-bore / twin-core tunnels pass under seven miles of service / surface railway track.
- 5 Did you use a tunnel / funnel drill like the ones / one in this photo?
- 6 The rock around / ground under London was so hard that we bored / wore out six of them.
- 7 It means / seems we spent £17 / £70 million on drills.

- 3 Use the words and the verbs in the box to complete the text about antifreeze.

finally first next at this stage then increase open pour prevent screw  
 unscrew use use

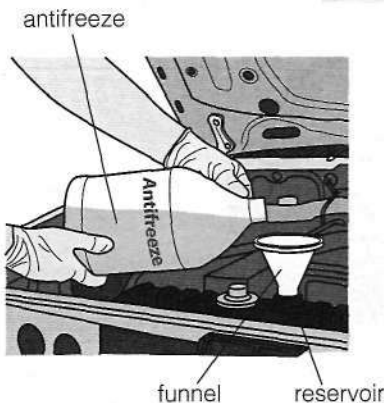

Antifreeze (1) \_\_\_\_\_ to prevent the water in the radiator from freezing. Rust (2) \_\_\_\_\_ from building up in the radiator system by the use of antifreeze. Also, the boiling point of the water in the cooling system (3) \_\_\_\_\_.

(4) \_\_\_\_\_ the bonnet of the car (5) \_\_\_\_\_.

(6) \_\_\_\_\_ the cap to the reservoir (7) \_\_\_\_\_.

(8) \_\_\_\_\_ the antifreeze (9) \_\_\_\_\_ into the reservoir. (10) \_\_\_\_\_, a funnel (11) \_\_\_\_\_ to avoid spilling antifreeze onto the car. (12) \_\_\_\_\_, after pouring in the correct amount, the cap (13) \_\_\_\_\_ back on.

## 2 Manufacturing

1 The pictures show the stages of manufacturing ice cream. Match them with the speech bubbles.

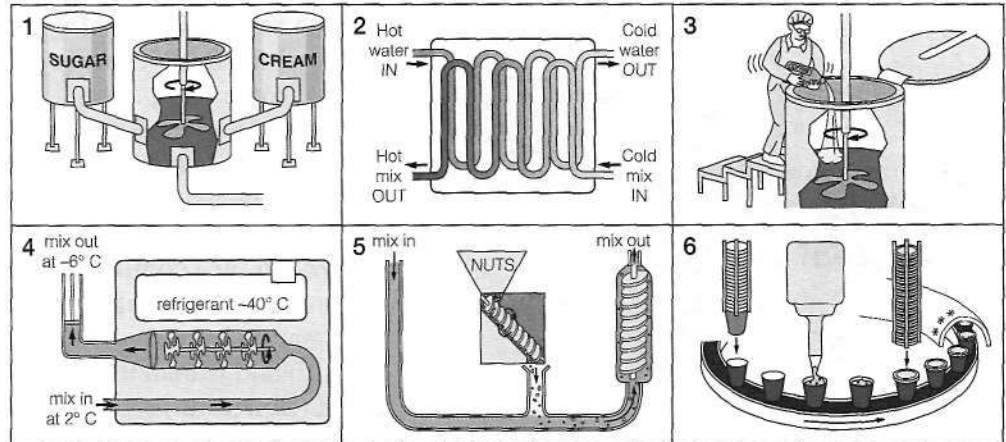

A We heat the mix to  $82^{\circ}\text{C}$  to kill off bacteria. (1). Then we cool the mix rapidly to  $4^{\circ}\text{C}$ .  
Picture \_\_\_\_\_

B Here we pack the ice cream in tubs and put it into a blast freezer at  $-30^{\circ}$  to  $-40^{\circ}\text{C}$ . So we freeze the tubs of ice cream to make them harder.  
Picture \_\_\_\_\_

C We add flavours and colours to the mix.  
Picture \_\_\_\_\_

D Here we pump the mix through a special barrel freezer. We whip a lot of air into it at the same time. Up to half the volume of ice cream is air.  
Picture \_\_\_\_\_

E Here we weigh all the ingredients and mix them together in large tubs. We use cream, milk and sugar to make ice cream.  
Picture 1

F Here we add any fruits, nuts or biscuit pieces to the semi-frozen mixture.  
Picture \_\_\_\_\_

2 Write a description of the manufacturing process, using the passive. Use the linkers from the box. One of them is placed in the middle of a section.

Finally Next First Simultaneously Then First At this point

1 *First, all the ingredients are weighed and mixed together in large tubs. Cream, milk and sugar are used to make ice cream.*

- 2 \_\_\_\_\_
- 3 \_\_\_\_\_
- 4 \_\_\_\_\_
- 5 \_\_\_\_\_
- 6 \_\_\_\_\_

### 3 Communications

1 Write the numbers of the satellite parts next to the descriptions in the text.

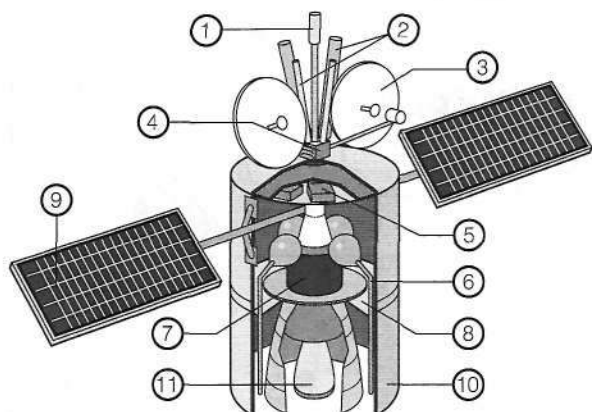

Each satellite has a frame or **bus (10)**, which is strong enough to hold everything together.

All satellites need a source of **electrical power**. This comes from solar panels (\_\_\_\_). However, these do not work when the satellite is in shadow, on the side of the Earth away from the Sun. Therefore a ring of rechargeable batteries (\_\_\_\_) is installed.

All the satellite's systems are monitored and controlled by a **computer** (\_\_\_\_).

All satellites have antennas, which receive radio wave information from the ground (**uplink**)

(\_\_\_\_) and transmit radio wave information back to Earth (**downlink**) (\_\_\_\_). The antennas (\_\_\_\_) are

connected to the **radio** (\_\_\_\_) on the satellite. Satellites are controlled by the ground-control crew in many ways. They can change the satellite's orbit by firing the main rocket (\_\_\_\_) or request information.

All satellites have an **attitude control system**, which controls the positioning of the satellite. For example, the side with the solar panels may need to face the sun. Or the side with the camera or antennas may need to face the Earth. Puffer jets (\_\_\_\_) use gas from a pressurised tank (\_\_\_\_) to change the attitude of the satellite.

Satellites carry items of **equipment** that 'listen, speak, see and touch'.

In addition to radio antennas, they may carry a telescope or camera, a thermometer or sensors.

2 What do these words in the text refer to? Underline your answers.

- |                   |                        |                            |
|-------------------|------------------------|----------------------------|
| 1 which (line 1)  | a) satellite           | b) bus                     |
| 2 This (line 3)   | a) electrical power    | b) frame                   |
| 3 these (line 4)  | a) solar panels        | b) satellites              |
| 4 which (line 10) | a) satellites          | b) antennas                |
| 5 They (line 15)  | a) ground-control crew | b) ways                    |
| 6 which (line 17) | a) attitude            | b) attitude control system |
| 7 that (line 22)  | a) items               | b) equipment               |

3 Join these pairs of sentences. Use *who* or *which*.

- The first artificial satellite was a metal ball. It measured 1 metre across and weighed 83 kg.
- It had four long antennas. These sent radio signals back to Earth.
- The first creature in space was a dog called Laika. It spent ten days in orbit in 1957.
- In 1968, Apollo 8 sent photos back to Earth. It orbited the Moon.
- The first man on the Moon was Neil Armstrong. He landed there in 1969.
- The first tourist in space was a man called Mark Shuttleworth. He paid \$20 million for his trip.
- Two Mars Rovers sent back information about the planet to Earth. They landed in 2003.

*Example:* 1 The first artificial satellite was a metal ball, which measured 1 metre across and weighed 83 kg.

## 4 Word list

NOUNS (tunnels)	NOUNS (communications)	NOUNS (cars)	VERBS (cars)
belt	communications	air conditioning	deliver
chute	satellite	assembly line	drill
conveyor belt	digital TV card	body shop	grip
cutter	feed horn	bonnet	strengthen
cutter face	frequency	bumper	supply
drill	high frequency	chassis	transport
hydraulic cylinder	low frequency	chassis line	weld
manpower	orbit	component	<b>ADJECTIVES</b>
propeller	PC monitor	drive shaft	rusty
scoop	satellite dish	laser guide	<b>ADVERBS</b>
steel shoe	transmitter	oil drain plug	finally
tooth/teeth	TV station	oil filler cap	first
	<b>VERBS (communications)</b>	paint shop	lastly
	convert	panel shop	meanwhile
	display	roller	next
	extract	rust	now
	process	suspension	rightside up
	reflect	transmission	simultaneously
		trim line	then
			upside down

1 Cover the table. Make compound nouns from the words in the boxes.

conveyor	cap	laser	card
drive	line	paint	monitor
hydraulic	cylinder	PC	horn
drain	shaft	satellite	satellite
assembly	belt	feed	dish
air	conditioning	communications	shop
filler	plug	DTV	guide

2 Write adverbs from column 4 on the correct line.

At the beginning: *first*, \_\_\_\_\_

After this: \_\_\_\_\_

At the same time: \_\_\_\_\_

At the end: \_\_\_\_\_

## Section 1

- 1 Complete the dialogue between a car salesman (S) and a customer (C). Make comparisons between the two cars.

	1000	1300
Engine size	1.0 litre	1.3 litre
Top speed	155 kph	170 kph
Acceleration	0-100 kph: 15.7 seconds	0-100 kph: 11.5
Fuel tank capacity	40 litre	50 litre
Fuel consumption (combined)	18.5 km/litre	16.5 km/litre

S: The 1300 is quite a bit (1) *faster* (fast) than the 1000.

C: Yes, but doesn't it use (2) *more* petrol?

S: Sure, the fuel consumption on the 1300 is a little bit (3) \_\_\_\_\_ (high).

C: So, I'll have to fill up with petrol (4) \_\_\_\_\_ (often).

S: In fact, the 1300 has a (5) \_\_\_\_\_ (large) fuel tank.

C: How much (6) \_\_\_\_\_ (large)?



S: It holds 10 litres (7) \_\_\_\_\_ than the 1000. So that evens things out. The 1300 has (8) \_\_\_\_\_ (great) acceleration. So it's much (9) \_\_\_\_\_ (safe), because you can overtake (10) \_\_\_\_\_ (fast).

C: Because it's got a (11) \_\_\_\_\_ (powerful) engine, I suppose.

S: Of course, The 1300 is (12) \_\_\_\_\_ (good) value for money.

C: But it's quite a bit (13) \_\_\_\_\_ (expensive). You see, the 1300 is (14) \_\_\_\_\_ \$13,000, and I want to spend (15) \_\_\_\_\_ than \$10,000. So the 1000 will be (16) \_\_\_\_\_ (good) for my budget.

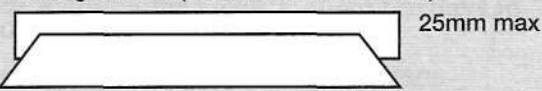
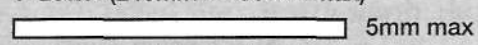
- 2 Complete the left-hand side of the leaflet about post sizes.

<p><b>1 Letter:</b> If your item fits inside the blue area, i.e. is less than 240mm × 165mm, is no thicker than 5mm and weighs under 100g, it is classed as a <b>Letter</b>.</p> <p><b>2 Large Letter:</b> If your item fits inside the _____ area, i.e. is _____, is _____ 25mm and weighs _____ 750g, it is classed as a <b>Large Letter</b>.</p> <p><b>3 Packet:</b> If your item fits inside the _____ area, i.e. is _____ 353mm × 250mm or is _____ 25mm and weighs _____ 750g, it is classed as a <b>Packet</b>.</p>	<p><b>3 Packet</b></p> <p><b>2 Large Letter (353mm × 250mm max)</b></p>  <p><b>1 Letter (240mm × 165mm max)</b></p>  <p>PLACE CORNER OF ITEM HERE</p> 
--	---

## Section 2

1 Put the verbs in brackets into the passive and fill in the missing words.

Corrugating the cardboard

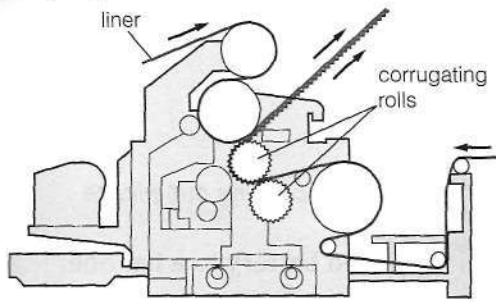

Corrugated cardboard

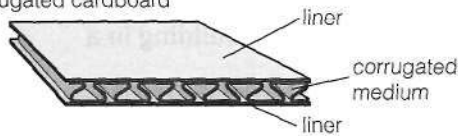

Die-cutting tool

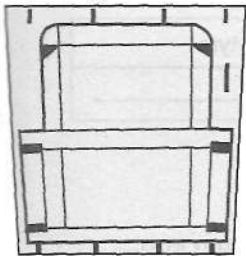

Die-cutting blank

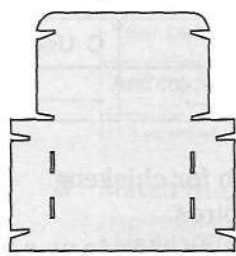

Finished product

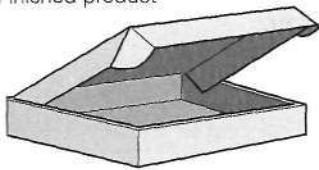

### How corrugated cardboard is made.

Large rolls of paper, (1) *which weigh* about 2.7 tonnes, (2 *transport*) *are transported* from the paper mill to the cardboard packaging factory. Here they (3 *load*) \_\_\_\_\_ into one end of a huge machine called a corrugator, (4) \_\_\_\_\_ is 91 metres long. One roll of paper (5 *press*) \_\_\_\_\_ between two heavy corrugating rollers, (6) \_\_\_\_\_ are heated (7) \_\_\_\_\_ steam to a temperature of 185° C. (8) \_\_\_\_\_, this corrugated paper (9 *glue*) \_\_\_\_\_ between two other layers of paper, called liners. At the end of the machine, the roll of corrugated cardboard (10 *trim*) \_\_\_\_\_ by slitting wheels and (11 *cut*) \_\_\_\_\_ into large sheets called blanks.

(12) \_\_\_\_\_, the cardboard blanks (13 *feed*) \_\_\_\_\_ into a printing machine, (14) \_\_\_\_\_ prints the product information and the manufacturer's name. After the printing process, some batches of cardboard (15 *wax*) \_\_\_\_\_ (16) \_\_\_\_\_ make them water-resistant.

Die-cutting is a process which cuts a cardboard blank into the required shape. (17) \_\_\_\_\_, a die-cutting tool (18 *make*) \_\_\_\_\_ out of a flexible base and sharp raised lines of steel. This (19 *fit*) \_\_\_\_\_ onto a roll in a rotary die-cutting machine. Cardboard blanks (20 *feed*) \_\_\_\_\_ into one end of the machine and pieces of cardboard (21 *cut*) \_\_\_\_\_ out of the blanks by the die-cutting tool. (22) \_\_\_\_\_, the blanks (23 *band*) \_\_\_\_\_ together and (24 *transport*) \_\_\_\_\_ to the customer.

2 Answer these FAQs about satellites. Write full sentences using the passive.

1 How do we put satellites into orbit?

a) location: round the Earth b) method: rockets

*Satellites are put into orbit round the Earth by rockets.*

2 How do we provide electricity on a satellite?

a) method: cells b) location: solar panels

3 How do we change a satellite's orbit?

a) method: rocket b) location: base of the satellite

4 How do we collect weather pictures all over the world?

a) method: dozens of satellites b) location: in orbit

5 How do satellites transmit weather photos?

a) destination: back to Earth b) method: radio signals

6 How do we use images from survey satellites?

a) method: computer b) purpose: to update maps



## 1 Uses

1 Rewrite the sentences, using the word(s) in brackets.







- 1 Chisels cut out pieces of wood. (are for) *Chisels are for cutting out pieces of wood.*
- 2 Jump leads carry an electrical current from a charged battery to a flat one. (used)
- 3 Carburettors mix fuel with air. (designed)
- 4 The two thick fins at the rear of the ship are like stabilisers. (act as)
- 5 Lightning conductors carry electricity down the side of a building in a thunderstorm. (designed)
- 6 The impeller on a jet ski is like a propeller. It pushes the craft through the water. (act as ... and)

2 Read the sentences. Write the sentence numbers in the correct columns.

A Uses for a net	B Uses for a sheet	C Uses for a tyre
_____	1, _____	_____

- 1 You can use it to provide shade.
- 2 You can split it and use it as a water dish for chickens.
- 3 It can be used for protecting fruit from birds.
- 4 You can use several of them to catch falling objects on a building site.
- 5 You can cut it up and make rubber shoes from it.
- 6 You can carry tools in it.
- 7 They can act as weights to keep down a large plastic cover.
- 8 You can use it to climb a tree.
- 9 It can be used for containing luggage loads in a plane.
- 10 It can be used for protecting food from flies.
- 11 Three of them placed vertically can act as a growing-pot.
- 12 You can use it to prevent chickens from flying away.

3 Write your own sentences for the pictures in your exercise book.

1  <i>Several of them ...</i>	2  <i>You can ...</i>	3  <i>You can ...</i>
4  <i>Several of them ...</i>	5  <i>You can ...</i>	6  <i>It can ...</i>

## 2 Appearance

- 1  11 Listen to the descriptions. Write the description number next to the right picture.

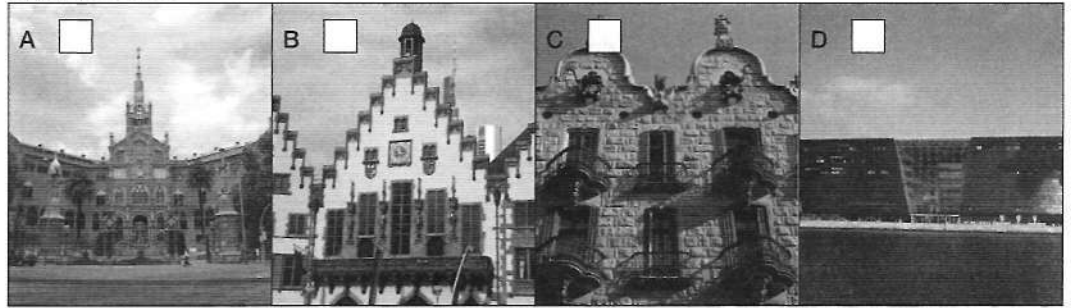

- 2  12 Listen and write notes about three of the buildings in Exercise 1.

	Building A	Building C	Building D
City			
Country			
Type of building			
Year completed			
Architect <sup>(1)</sup>			

(1) A person who designs a building

- 3 Match the adjectives in the box to the nouns.

circular conical cubic cylindrical dome-shaped hemispherical  
rectangular semi-circular spherical square triangular

Nouns	Adjectives	two-dimensional (2D)	three-dimensional (3D)
1 triangle	triangular	✓	
2 cone			✓
3 rectangle			
4 cylinder			
5 semi-circle			
6 dome			
7 hemisphere			
8 circle	circular		
9 square			
10 cube			
11 sphere			

- 4  13 Are the words in 3 two- or three-dimensional? Tick the correct box. Then listen and check.

### 3 Definitions

1 Match the products with the sentences.

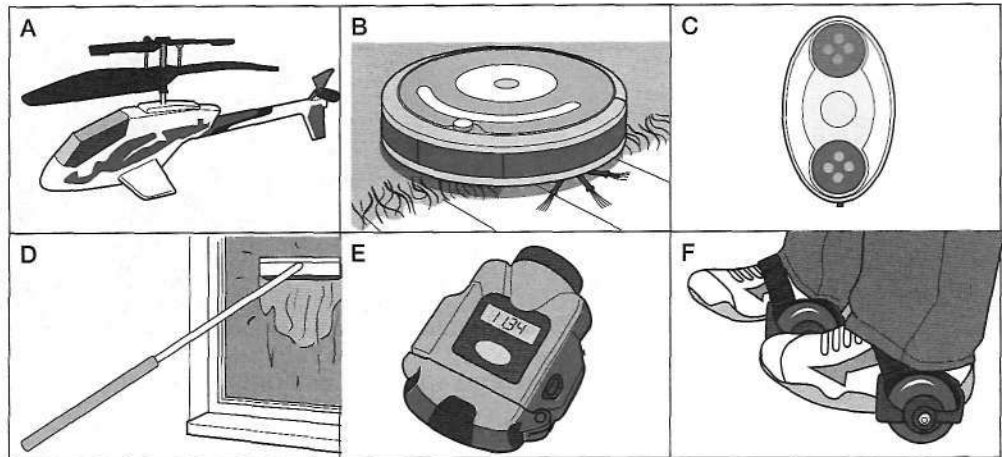

- 1 The Ultrasonic Distance Meter is portable; it allows you to measure large rooms.
- 2 The Zoomba Vacuum Cleaner is rechargeable; it cleans floors automatically.
- 3 The Garage Parking Sensor fits to your garage wall; it helps you to park safely.
- 4 The Ticko mini helicopter is radio-controlled; it flies for up to 10 minutes.
- 5 Street Gliders are two-wheeled; they fit on the heels of your shoes.
- 6 The Extendable Window Cleaner extends up to 3.5 metres; it allows you to clean high windows from the ground.

2 Rewrite the sentences in 1 using the words 'that' or 'which'.

sensor system   tool   instrument   device   toy   robot   which   that

1 *The Ultrasonic Distance Meter is a portable instrument which allows you to measure large rooms.*

- 2 \_\_\_\_\_
- 3 \_\_\_\_\_
- 4 \_\_\_\_\_
- 5 \_\_\_\_\_
- 6 \_\_\_\_\_

3 Write sentences using the words and phrases in the box.

around   at the top   at the bottom   from   into   out of   through

A sales person	is	people	that	service and repair equipment.
An inventor	are	a person	who	allow you to access and download information.
Entrepreneurs		someone	which	takes an order.
Investors		systems		designs new devices.
The Internet		a system		put money into a new business.
Websites				connects PC users and websites.
Technicians				set up new businesses.

## 4 Word list

NOUNS (shapes)	VERBS (devices)	NOUNS (other)	VERBS
circle	calculate	adjuster	absorb
cone	conduct	alarm pod	adjust
cube	contain	appearance	beep
cylinder	generate	assistance	consist
dome	propel	bass amplifier	design
hemisphere	receive	bend	download
rectangle	stabilise	booster car seat	invent
semi-circle	transmit	bridge (boat)	navigate
sphere	<b>NOUNS (devices)</b>	capsule	relay
square	calculator	dashboard	submerge
triangle	conductor	disaster victim	<b>ADJECTIVES</b>
<b>ADJECTIVES (shapes)</b>	container	dolphin	audible
	generator	entrepreneur	digital-sonar
circular	propeller	helm unit	overboard
conical	receiver	hull	ultrasonic
cubic	stabiliser	hydrophone	visible
cylindrical	transmitter	inventor	<b>ADVERBS</b>
dome-shaped	<b>NOUNS (tools and devices)</b>	junction	automatically
H-shaped		link	basically
hemispherical	carburettor	moisture	<b>PREPOSITION</b>
rectangular	chain	ocean liner	via
semi-circular	chisel	onion	
spherical	clamp	profit	
square	jump lead	skyscraper	
triangular	ladder	soup bowl	
	protractor	surfboard	
	skewer	transducer	
		tag	
		tape	
		torque wrench	
		tripod	
		wedge	

- 1 Circle 16 words that were in the text about the LifeGuard system for rescuing men overboard. Then check your list with the text in 5, Section 2 of the Course Book, page 55.

## 1 Safety



### 1 Match the sentence halves.

- |   |                                |
|---|--------------------------------|
| 1 Heavy crates are lifted               | a) to pallets.                 |
| 2 Storage boxes are stacked             | b) by hand trucks.             |
| 3 Light pallet loads can be moved       | c) at once.                    |
| 4 Cylinders must be strapped            | d) by fork-lift trucks.        |
| 5 Aisles have to be kept clear          | e) by specialist safety staff. |
| 6 Chemical spills need to be cleaned up | f) on shelves.                 |
| 7 Blockages must be removed             | g) of rubbish.                 |

### 2 Complete the safety regulations for fork-lift trucks. Use the modals and the passive form of the verbs in brackets, with *not* if necessary.

- All fork-lift trucks *should be maintained* (should / maintain) by a specialist contractor.
- Safe operating instructions \_\_\_\_\_ (should / provide) for each type of fork-lift truck.
- Unqualified operators \_\_\_\_\_ (should / allow) to drive fork-lift trucks.
- Vehicles \_\_\_\_\_ (must / leave) unattended with the engine running.
- Trucks \_\_\_\_\_ (need / park) overnight in designated areas with the brakes on.
- A battery-powered truck \_\_\_\_\_ (need / put) on charge at the end of each working day.
- A truck \_\_\_\_\_ (must / take) on the highway without the warehouse manager's permission.
- Levels of oil, water and antifreeze \_\_\_\_\_ (need / check) at the start of each working day.

### 3 Rewrite the Safety Officer's notes for a fire evacuation procedure.

#### If you hear the fire alarm:

- if you hear etc. → stay calm *if you hear the fire alarm, stay calm.*
- when fire alarm sounds → building evacuated immediately *MUST!* \_\_\_\_\_
- ✓ stop work + switch off machines  
\_\_\_\_\_
- X stop + gather personal belongings  
\_\_\_\_\_
- X use lift \_\_\_\_\_
- X re-enter building → Fire Officer gives all-clear  
\_\_\_\_\_

## 2 Emergency

1 Write sentences for a diving safety manual, using 'must' or 'should'.

- 1 If a diver's position is not known, it's necessary to locate them immediately.  
*If a diver's position is not known, they must be located immediately.*
- 2 If a diver is trapped underwater, we recommend freeing them with a knife.  
*If a diver is trapped underwater, they should be freed with a knife.*
- 3 If a diver's oxygen is low, we recommend providing an extra air cylinder.

---

- 4 If a casualty is not buoyant, we recommend inflating their wetsuit.

---

- 5 If a casualty is slightly injured, we recommend giving first aid in the boat.

---

- 6 If a casualty is not breathing, it's necessary to carry out artificial respiration at once.

---

- 7 If a casualty is seriously injured, it's necessary to phone the rescue services.

---

2 Read the interview about cave diving. Complete the notes below.

**Interviewer:** What's it like cave diving in the UK?

**Diver:** It's nothing like diving in Mexico or France. For a start, the water is very cold, and you can't see anything because there is so much silt in the water. Also, the caves here are small and narrow, so you shouldn't attach your air bottle to your back. If you do, you'll get stuck!

**Interviewer:** So how do you get started?

**Diver:** First, you need to have the right equipment for cave diving. You should wear a helmet and a wetsuit; it's thinner than a drysuit. You should also take thick direction lines, so you don't get lost underwater. 4-6 mm thickness is the minimum.

**Interviewer:** Is it a good idea to dive with a buddy, I mean another diver?

**Diver:** No, you should never do that. You can't see them and they may get in the way or block your exit. And one more thing: always ask permission from the landowner before you visit a cave on their property.

### DOS

get permission from \_\_\_\_\_  
use underwater lines so \_\_\_\_\_  
wear \_\_\_\_\_

### DON'TS

wear \_\_\_\_\_  
attach \_\_\_\_\_  
dive with \_\_\_\_\_

3 Rewrite this article on 'buddy breathing'. Change the male/female forms to *they / them / their / theirs*.

'Buddy breathing' is a system of sharing one cylinder of air between two divers. Sometimes you still have air left in your tank at the end of a dive, but your partner has none in (1) his/hers \_\_\_\_\_. At this point, you give (2) him/her \_\_\_\_\_ your face mask to breathe through. After (3) he/she has taken \_\_\_\_\_ a breath, (4) he/she passes \_\_\_\_\_ the mask back and you take a breath. You continue this while you both ascend. Buddy breathing is for emergencies. You should manage your own air supply, and your buddy should manage (5) his/hers \_\_\_\_\_.

### 3 Directions

1  14 Complete the directions.

- 1 Go *straight ahead* at the crossroads.
- 2 Turn left at the \_\_\_\_\_.
- 3 At the roundabout, take the \_\_\_\_\_.
- 4 At the roundabout, go down the slip road and \_\_\_\_\_.
- 5 \_\_\_\_\_ the station car park and turn left.
- 6 Take the \_\_\_\_\_.
- 7 \_\_\_\_\_ on your left.
- 8 Turn right at the \_\_\_\_\_.

2  15 Listen to two sets of telephone directions, which start at Point X on the map. Follow the routes and find the destinations on the map.

Directions 1: Destination A / B / C / D (circle)

Directions 2: Destination A / B / C / D (circle)

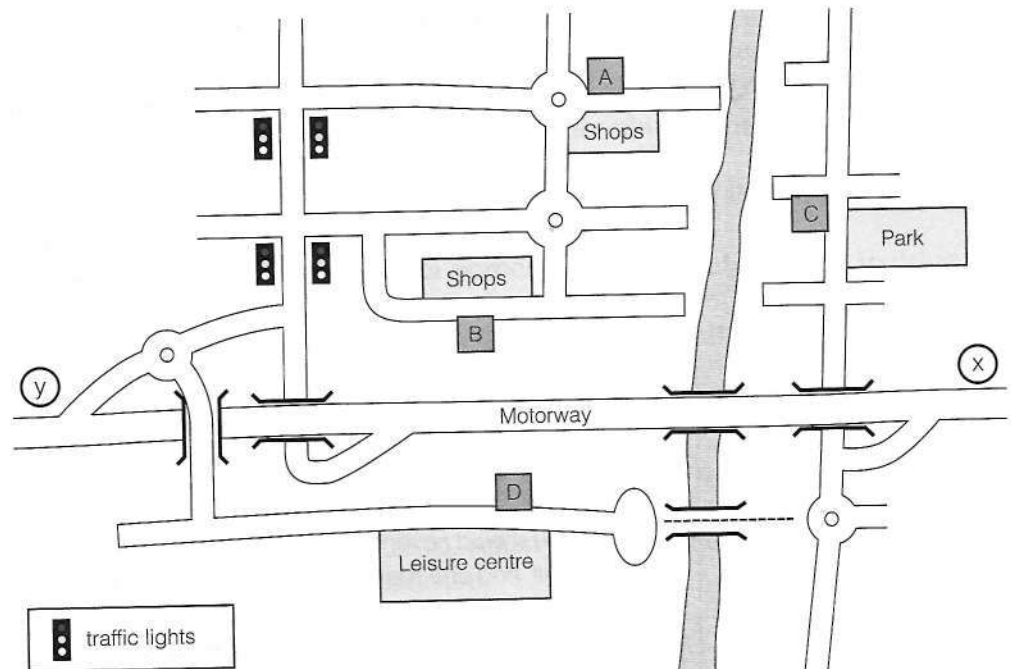

3 Write email directions starting at Point Y on the map, like the example in 3, Section 3 of the Course Book, page 47. Explain how to get to the BMG office in the Swindon Business Park on the map (Point D).

Thank you for \_\_\_\_\_  
 \_\_\_\_\_ Swindon Business Park.

---



---



---



---



---

## 4 Word list

NOUNS (factory)	NOUNS (diving)	NOUNS (directions)	VERBS
aisle	anchor	crossroads	attend to
belongings	oxygen	flyover	attract
blockage	scuba diver	gantry	authorise
chemical spill	sea bed	lake	chain
crate	shipwreck	motorway	handle
evacuation	wetsuit	roundabout	inflate
fork	<b>NOUNS (medical)</b>	sketch map	injure
freezer	artificial respiration	slip road	locate
hand truck	cardio-pulmonary resuscitation	traffic lights	overload
liquid		turning	purchase
pallet	casualty	underpass	recommend
procedure	first aid	<b>ADJECTIVES</b>	secure
ramp	pulse	available	stack
safety issue	recovery position	buoyant	strap
shelf		calm	suggest
warehouse		level	tow
workplace			

1 Cover the Word list and complete these compound nouns. Then check.

- |                   |                       |
|-------------------|-----------------------|
| 1 _____ aid       | 6 _____ respiration   |
| 2 _____ diver     | 7 _____ resuscitation |
| 3 _____ issue     | 8 _____ spill         |
| 4 _____ position  | 9 _____ suit          |
| 5 _____ procedure | 10 _____ truck        |

2 Use verbs from the Word list in their correct forms to complete the sentences.

- 1 First, the diving trainer managed to \_\_\_\_\_ the missing diver.
- 2 Then we \_\_\_\_\_ the casualty.
- 3 Then we managed to \_\_\_\_\_ attention by sounding our alarm.
- 4 Finally, they \_\_\_\_\_ our boat back to the port.
- 5 The report \_\_\_\_\_ a new system of safety procedures.
- 6 The manager has \_\_\_\_\_ the purchase of new fire extinguishers.
- 7 Gas cylinders must \_\_\_\_\_ to the pallet.
- 8 Don't \_\_\_\_\_ the hand truck!
- 9 Crates must not \_\_\_\_\_ more than three high.
- 10 Those boxes must \_\_\_\_\_ carefully. They contain glass.
- 11 Tyres must \_\_\_\_\_ to the correct pressures.



## Section 1

1 Underline the correct spelling and write the word in the space.

1	generater	<u>generator</u>	<i>generator</i>
2	transmitor	transmitter	_____
3	carboretter	carburettor	_____
4	protractor	protractor	_____
5	stabilizer	stabilizor	_____
6	conductor	conductor	_____
7	reciever	receiver	_____
8	propelor	propeller	_____

2 Match the devices with their explanations.

1 V-belt	a) Triangular in shape, this supports the sloping roof of a house.
2 U-bolt	b) A steel device for attaching a cycle to street furniture.
3 T-junction	c) A fitting that goes on a shaft.
4 U-bend	d) A tool for fixing a machine firmly to a workbench.
5 A-frame	e) A fitting with a plate and two bolts, used a lot on boats.
6 D-lock	f) A water trap which prevents smells from coming out of a waste pipe.
7 G clamp	g) This drives things like the fan and water pump in a car.
8 E-clip	h) A rectangular pipe fitting where two pipes meet.

3 Read the article about a new anti-collision system. Underline the best words/phrases. Then check your answers.

Until now, ships' radar anti-collision systems (ACS) have only (1) *transported / operated* over greater distances. They have been (2) *able / unable* to track ships closer than about 4.8 kilometres. Existing ACS (3) *information / equipment* is difficult to operate, and requires a separate (4) *display / instrument* and large amounts of space.

Now an inventor has developed a new ACS. Its radar system can (5) *detect / measure* targets at short and long distances.

The system can be modified through its computer to carry out extra (6) *functions / dimensions*. For example, the (7) *transmitter / display* can show map lines with shipping channels near a port. Also, it can be (8) *programmed / calculated* to ignore targets inside certain areas.

The new ACS (9) *contains / consists* of a display screen, a computer, two sets of switches and a joystick. Information from the radar system is displayed, as normal, on a display screen. A first set of switches instructs the computer to produce data for display on the screen. Each of the first set of switches is (10) *labelled with / attached to* a name or abbreviation which describes the function. A second set of switches (11) *treats / controls* a second set of functions through the computer program. Also, the ship's own position can be moved from the centre of the screen (12) *via / by means of* the joystick.

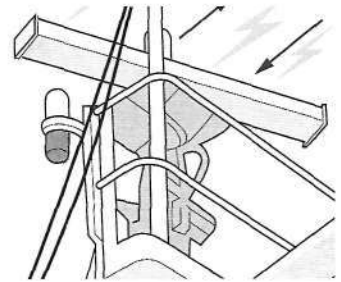

## Section 2

- 1 Complete the safety manual about the transport of explosives. Use the verbs from the box in the passive, or in the past participle form, with or without *not*.

**Sentences 1–6:**

allow carry convert display inspect  
lock require tow transport use

**Sentences 7–11:**

authorise avoid carry carry out  
carry out leave load load permit  
refuel secure turn off

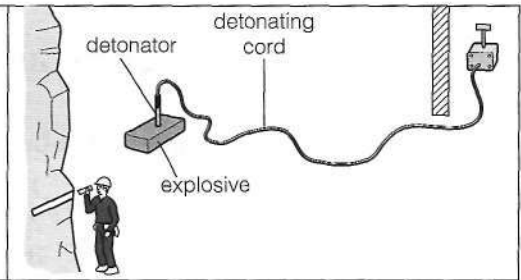

**Dangerous goods – transport requirements for explosives**

- 1 Explosives (must) *must be transported* in metal boxes with a wooden inner liner. The load (must) \_\_\_\_\_ except when loading or unloading.
- 2 Trailers \_\_\_\_\_ by passenger vehicles (must) \_\_\_\_\_ to transport explosives.
- 3 EXPLOSIVES signs (must) \_\_\_\_\_ on all four sides of the vehicle.
- 4 A fire extinguisher \_\_\_\_\_. No smoking \_\_\_\_\_ within 6 metres of the vehicle.
- 5 The vehicle (must) \_\_\_\_\_ to transport explosives and (must) \_\_\_\_\_.
- 6 Emergency equipment (three triangular signs, three portable flashing lights) (must) \_\_\_\_\_.
- 7 Up to 500 detonators (may) \_\_\_\_\_ with up to 250 kg of explosives. The detonators (must) \_\_\_\_\_ in a separate compartment of the vehicle, at least 2 metres away.
- 8 Night-time driving \_\_\_\_\_, if this \_\_\_\_\_ by the transport supervisor.
- 9 A parked vehicle \_\_\_\_\_ with explosives (must) \_\_\_\_\_ unattended.
- 10 Populated areas (should) \_\_\_\_\_ wherever possible.
- 11 Refuelling (should) \_\_\_\_\_ before the explosives \_\_\_\_\_. If a vehicle (have to) \_\_\_\_\_ during the trip, this (should) \_\_\_\_\_ in the most isolated place available, with the engine \_\_\_\_\_.

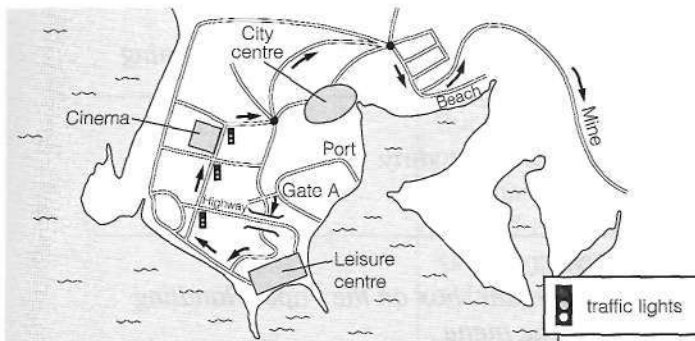

- 2 Find the route (driving on the left) from Gate A of the port to the mine. Write an email giving directions to the lorry driver.

*Example: Leave the port by Gate A. You'll come to a crossroads. Turn left at the crossroads.*

...

## 1 Technical support

### 1 Match the nouns and their definitions.

- |                             |  |
|-----------------------------|--|
| 1 attachment                | a) an advert that suddenly appears on a screen without you searching for it        |
| 2 browser                   | b) a connection between a computer and the Internet via radio waves                |
| 3 firewall                  | c) the set of numbers which identifies every computer on the Internet              |
| 4 IP address <sup>(1)</sup> | d) you can lock this on your computer to stop other users from changing it         |
| 5 password                  | e) a series of letters or numbers that you type into a computer in order to use it |
| 6 pop-up                    | f) software that allows you to access websites on the Internet                     |
| 7 resolution setting        | g) a network security system used to restrict external and internal traffic        |
| 8 security setting          | h) you can change this to make images larger or smaller, or in colour              |
| 9 wireless                  | i) something that you send with an email, e.g. a document                          |



(1) Internet protocol

### 2 For each printer problem, write a diagnosis (D) and suggest a solution (S), using the guide words. Refer to the language box on Course Book page 53.

- 1 The printer always prints in colour.  
*Diagnosis: you have definitely checked the 'Colour' box. Suggestion: check the 'Black' box*  
*Example: You must have checked the 'Colour' box. Try checking the 'Black' box.*
- 2 The printer is using a lot of ink.  
*D: perhaps you checked the 'Fine' box on the Print Quality menu. S: check the 'Draft' box on the menu*

---

- 3 The LED lights on the printer don't come on.  
*D: it's possible there is a loose connection. S: unplug the printer, plug it in again*

---

- 4 The pages come out blank, without any print.  
*D: it's certain the ink cartridge is empty. S: check the level of ink remaining*

---

- 5 There are gaps on the printed page.  
*D: the print head nozzles have probably become dirty. S: clean the print head nozzles*

---

- 6 Pages are printed in the wrong order.  
*D: you have definitely checked the 'Automatic' box on the Paper Handling menu. S: check the 'Reverse' button on the menu*

## 2 Reporting to clients

- 1 Put the verbs in brackets into the passive. Then match the sentence halves.

### **Design-and-Build.**

We offer a design-and-build service for all types of domestic and commercial projects.

Check our Portfolio section to see photos of several recent projects.

Please select → [Home](#) [Our clients](#) [Portfolio](#) [Quality](#) [Value](#) [Contact us](#)

1 Design-and-Build was <i>appointed</i> (appoint)	a) to allow wheelchair access.
2 Doorways _____ (widen)	b) to provide all-weather practice facilities.
3 A false ceiling _____ (construct)	c) to provide extra living space.
4 The covered walkway _____ (extend)	d) to provide an 'at home' office nearby.
5 Four indoor tennis courts _____ (build)	e) to enlarge the kitchen and dining area.
6 A lift _____ (install)	f) to supervise the project from start to finish.
7 The house _____ (extend) on two storeys	g) to hide electrical wiring and pipework.
8 A farm building _____ (convert)	h) to link the main building to the classrooms.
9 A single-storey extension _____ (build)	i) to provide disabled access to the upper floors.

1 f; 2 \_\_\_\_\_; 3 \_\_\_\_\_; 4 \_\_\_\_\_; 5 \_\_\_\_\_; 6 \_\_\_\_\_; 7 \_\_\_\_\_; 8 \_\_\_\_\_; 9 \_\_\_\_\_

- 2 Rewrite the draft email as a covering letter to a client. Set out your letter like the example in 5, Section 2 of the Course Book, page 55..

Ann,  
Pls will you draft a letter to our client at Nilsson including the details below. Enclose a print-out of our report, which I am sending you as an attachment. I'll be in the office on Monday. Thanks.  
Herbert Ritz,  
Project Manager

Client: Mr Tom Berghaus, Nilsson plc  
Contact details: Unit 38 West Business Park, Swindon SN42 6BH  
Subject: Quotation: Extension at Swindon office  
Letter: Thanks for your letter of 31 Jan 08, inviting us to prepare quotation for above project.  
We visited the site on 12 Feb 08 + took measurements & photos.  
Enclose report, plus outline plans and quotation.  
Our fees: agreed on a job-by-job basis; can be a fixed sum / an hourly rate/ a % of project cost.  
No charge for initial visit and quotation.  
If need to discuss details of report, don't hesitate, etc.  
Kind regards,  
Yours, etc.

### 3 Dealing with complaints

- 1 16 Listen to the phone dialogue from a customer with a complaint. Complete the Complaint Form.

Date and time of call	10.45 2008/02/25
Name of customer	
Order number	
Description of goods	
Model number	
Details of complaint	
Solution offered	<input type="checkbox"/> <i>replace</i> <input type="checkbox"/> <i>repair</i> <input type="checkbox"/> <i>refund</i> <input type="checkbox"/> <i>reduce</i>
Customer response	<input type="checkbox"/> <i>accept</i> <input type="checkbox"/> <i>reject</i>

- 2 17 Match six dialogues to six of the damaged articles.

1: \_\_\_\_\_ 2: \_\_\_\_\_ 3: \_\_\_\_\_ 4: \_\_\_\_\_ 5: \_\_\_\_\_ 6: \_\_\_\_\_

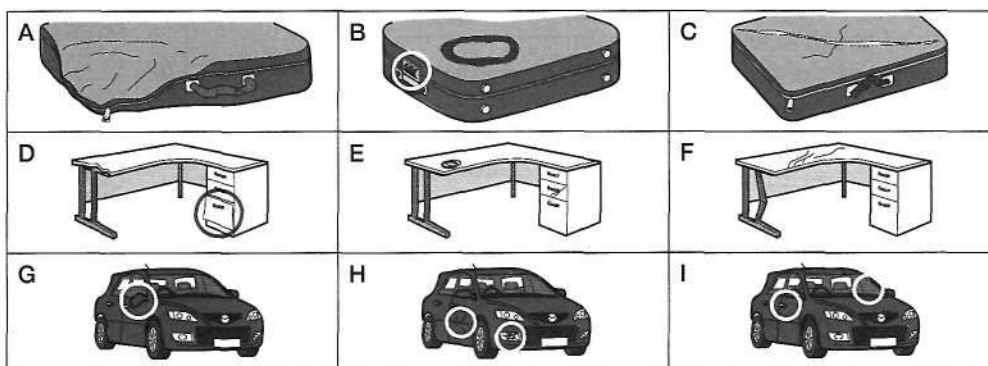

- 3 Reply to a letter of complaint, using the phrases in the box.

complaining about / However, / I am pleased to inform you / I am sorry to hear  
 I apologise for the inconvenience / in stock / purchase price / Please do not hesitate  
 Thank you for / Unfortunately, / Yours sincerely, / a full refund

Dear Ms Jensen,

(1) \_\_\_\_\_ your letter of 28th February  
 (2) \_\_\_\_\_ the portable TV with 18 mm-wide screen that you purchased at our store.  
 (3) \_\_\_\_\_ that the left-hand side of the case was cracked and that the screen was broken. (4) \_\_\_\_\_, we do not have any similar TVs (5) \_\_\_\_\_ as this model is no longer made. (6) \_\_\_\_\_, (7) \_\_\_\_\_ that we will give you (8) \_\_\_\_\_ of the (9) \_\_\_\_\_.  
 (10) \_\_\_\_\_ this has caused, especially since you took it with you on holiday expecting to use it.  
 (11) \_\_\_\_\_ to contact me if you have any queries about the refund.  
 (12) \_\_\_\_\_,  
 Tom Bryars  
 Store Manager

## 4 Word list



NOUNS (computer)	NOUNS (buildings)	NOUNS (complaints)	VERBS (complaints)
attachment	beam	corner	admit
browser	CCTV camera	detail	apologise
code	clarification	edge	crush
connection	client	evidence	deal (with)
connectivity	contractor	fault	destroy
diagnosis	parachute	front	jam
firewall	skyscraper	gesture	offer
image	smoke detector	goodwill	record
IP address	walkway	inconvenience	reduce
monitor	<b>VERBS (buildings)</b>	purchase	refund
password	appoint	query	replace
pop-up	expand	rear	split
resolution setting	monitor	reduction	summarise
security setting	<b>ADJECTIVES</b>	refund	twist
solution	blank	repair	<b>ADVERBS</b>
wireless	friendly	replacement	however
<b>VERBS (computer)</b>	helpful	surface	unfortunately
compress	impractical	sympathy	<b>PHRASES</b>
disconnect	loose		in addition
freeze	polite		in stock
interfere (with)	structural		
log (into)			
reboot			
reconnect			
reject			
uncheck			

1 Complete the steps in the complaints procedure, using verbs from column 4.

- 1 Don't \_\_\_\_\_ fault at the start.
- 2 \_\_\_\_\_ the details of the complaint on the computer.
- 3 \_\_\_\_\_ the problem to the customer.
- 4 \_\_\_\_\_ to the customer for the inconvenience.
- 5 \_\_\_\_\_ a discount off the next purchase, or
- 6 \_\_\_\_\_ the faulty article with a new one, or
- 7 \_\_\_\_\_ the purchase price in full.
- 8 \_\_\_\_\_ the next complaint.

## 1 Wave power

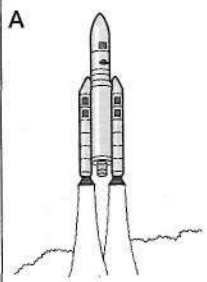
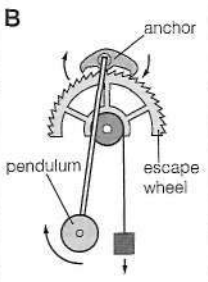
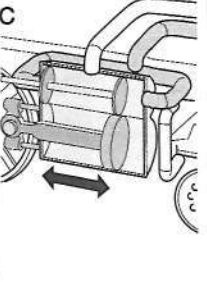
- 1  18 Complete the table. Then listen and check your answers.  
Types of motion: oscillating / rotary / reciprocating / linear

				
Type of	linear			
How it moves				rotates
Examples of machines			pistons	

- 2  19 Listen to a presentation about water jetting. Underline the phrases that you hear.

- Our range of pumps operates *a) compressions b) at pressures* from 70 to 2,750 bar.
- Pumps can operate to a maximum flow rate of *a) 773 litres per minute b) 73 litres per second*.
- Diesel units are available as *a) site b) side trailers* or *a) road trailers b) hose traders*.
- Standard electric units can be mounted on *a) skids b) skis* or trailers.
- Our accessory range includes hoses, *a) nozzles b) sockets*, guns and *a) footballs b) foot valves*.
- These allow *a) the operation b) the operator* to shut off the water jet with their foot.
- Hoses range from 6–32 *a) cm b) mm* in diameter, to suit all applications.

- 3  20 Listen to the next part of the presentation and note the details.

Industry	Application	Water jetting pressure (psi)
1 Automotive	Removing paint from <i>machinery</i> and _____	10,000 – _____
2 _____	Removing _____, dirt and oil, from _____ and _____	_____
3 _____ maintenance	Removing oil and _____ from roads, _____ and _____	5,000 – _____
	Clearing blockages from drains	10,000 – _____



## 2 Engines

- 1 Write the headings for the operation of a four-stroke diesel engine. Find letters for parts in the diagrams and write them in the text.

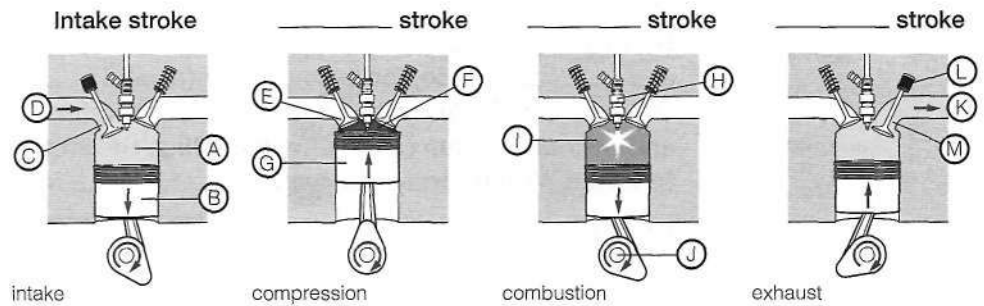

**Intake stroke.** Air (1) *D* alone is drawn into the cylinder (2) \_\_\_\_\_ through the intake port (3) \_\_\_\_\_ by the vacuum created by the descending piston (4) \_\_\_\_\_.

**Compression stroke.** The intake valve (5) \_\_\_\_\_ closes and the piston ascends (6) \_\_\_\_\_. Air is compressed in the top of the cylinder (7) \_\_\_\_\_ and is heated to 700–900° C.

**Combustion stroke.** Diesel oil (8) \_\_\_\_\_ is injected into the top of the cylinder by the oil injector (9) \_\_\_\_\_. It mixes with the compressed air above the piston. Combustion drives the piston downwards, and turns the crankshaft (10) \_\_\_\_\_.

**Exhaust stroke.** The exhaust valve (11) \_\_\_\_\_ opens. Exhaust gases (12) \_\_\_\_\_ are pushed out of the cylinder through the outlet port (13) \_\_\_\_\_ by the rising piston.

- 2 Read the article about the hybrid car. Which two things make the wheels go round?

You drive a hybrid car like an ordinary car. When you slow down, the electric motor turns into a generator, which recharges the batteries. At traffic lights, the petrol engine switches off. Take your foot off the brake and the car starts, using only its electric motor to provide maximum acceleration.

A hybrid car is more energy-efficient than one with a petrol engine alone. You can travel twice as far on 1 litre of petrol than in a petrol-driven car. In addition, the quantity of CO<sub>2</sub> that comes out of the exhaust is about 1 tonne less per year from a hybrid. Acceleration from 0–100 kph is 10.9 seconds, which is the same as for a 2-litre petrol engine.

Hybrid car owners pay less tax, and they have lower fuel consumption too. In addition to all this, they get a quiet car with good performance.

- 3 What do these words refer to?

- |   |                |  |                                    |                      |
|---|----------------|--|------------------------------------|----------------------|
| 1 | which (line 2) | a) the functioning of the electric motor | b) slowing down                    |                      |
| 2 | its (line 3)   | a) the car                               | b) the brake                       | c) your foot         |
| 3 | one (line 5)   | a) a car                                 | b) energy                          | c) a hybrid car      |
| 4 | that (line 7)  | a) 1 tonne of CO <sub>2</sub>            | b) the quantity of CO <sub>2</sub> | c) CO <sub>2</sub>   |
| 5 | which (line 8) | a) the given acceleration                | b) the given speed                 | c) the given time    |
| 6 | they (line 11) | a) less tax                              | b) car owners                      | c) hybrid car owners |



### 3 Cooling and heating

1 Complete the text with words from the language box on Course Book page 62.

When a *gas* condenses, it becomes a \_\_\_\_\_. When a \_\_\_\_\_ solidifies, it becomes a \_\_\_\_\_. When a \_\_\_\_\_ melts, it becomes a \_\_\_\_\_. When a \_\_\_\_\_ evaporates, it becomes a \_\_\_\_\_. So, for example, ice (a solid) \_\_\_\_\_ and becomes water (a liquid). And when water boils, the water (a liquid) \_\_\_\_\_ and becomes steam (a gas). With cooling, the steam \_\_\_\_\_ and turns to water. With freezing, the water \_\_\_\_\_ and turns to ice.

2 Fill in the blanks.

- 1 An \_\_\_\_\_ fan removes hot air from inside a room. (extractor/extraction)
- 2 The device has an 'On/Off' switch, which permits easy \_\_\_\_\_. (operator/operation)
- 3 \_\_\_\_\_ forms on the outside of cars during cold, damp nights. (condenser/condensation)
- 4 The function of the \_\_\_\_\_ is to compress the gas. (compressor/compression)
- 5 \_\_\_\_\_ of water from the soil is greatest at midday. (evaporator/evaporation)
- 6 \_\_\_\_\_ allows fresh food to be stored for longer. (refrigeration/refrigerant/refrigerator)
- 7 A \_\_\_\_\_ is the result of an equally strong physical force in the opposite direction. (reactor/reaction)
- 8 Deep-sea divers may have to spend time in a \_\_\_\_\_ chamber after returning to the surface. (decompressor/decompression)

3 Complete the text about an air-conditioning unit with words from the diagram and the box. Some words are used more than once.

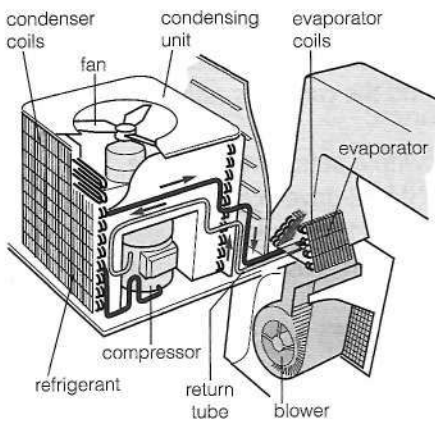

absorb provide reduce remove support

Air-conditioning (1) *removes* heat and humidity from the air and expels it outdoors. An independent air-conditioning unit (2) \_\_\_\_\_ cooled air on demand for rooms in offices, schools and houses. The temperature indoors (3) \_\_\_\_\_ by means of a closed system of tubes containing a refrigerant. A strong frame outside the house (4) \_\_\_\_\_ the condensing unit. The (5) \_\_\_\_\_ pumps the (6) \_\_\_\_\_ under pressure around the condenser coils. As it cools, it condenses and passes through a narrow tube, through an expansion valve, to the (7) \_\_\_\_\_ inside the building.

Inside, a rotary (8) \_\_\_\_\_ sucks warm air from the room and blows it over the (9) \_\_\_\_\_. As the refrigerant in the (10) \_\_\_\_\_ changes from liquid to gas, it (11) \_\_\_\_\_ heat and cools the air. The refrigerant (now a gas) flows through a larger (12) \_\_\_\_\_ to the compressor, which sends it round the (13) \_\_\_\_\_ again. At the top of this unit, a (14) \_\_\_\_\_ rotates and forces air over the (15) \_\_\_\_\_ to drive away the heat. Simultaneously, the (16) \_\_\_\_\_ inside the building forces the cooled, dehumidified air into the room.

## 4 Word list

WAVE POWER (NOUNS)	ENGINES (NOUNS)	COOLING AND HEATING (NOUNS)	COOLING AND HEATING (VERBS)
benefit	cam	coil	absorb
buoy	compression	compressor	compress
energy resource	crankshaft	condenser	condense
fossil fuel	cylinder	cycle	decompress
pendulum	exhaust port	evaporator	displace
<b>VERBS</b>	exhaust valve	expansion	evaporate
oscillate	explosion	fluid	expand
reciprocate	force	high pressure	extract
<b>ADJECTIVES (ALL)</b>	hydrogen	operation	melt
geothermal	ignition	principle	operate
linear	inlet	reaction	reverse
oscillating	intake port	refrigerant	solidify
reciprocating	intake valve	refrigeration	transfer
rotary	internal-combustion engine	upthrust	
<b>ADVERBS (ALL)</b>			
anti-clockwise	piston		
clockwise	spark plug		
rapidly	stroke		
simultaneously	torsion		
top dead centre (TDC)	vacuum		
	<b>VERBS</b>		
	compress		
	expand		
	ignite		

1 Label the diagram with nouns from column 2.

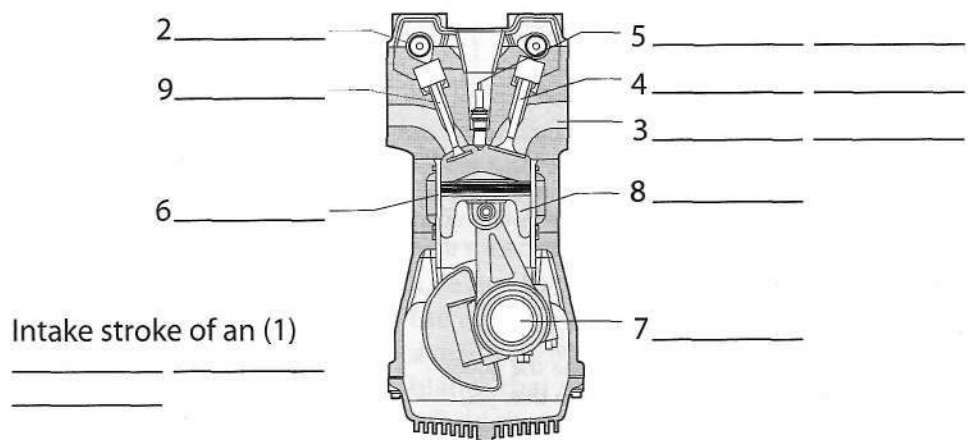

## Section 1

1 Complete these phone dialogues using the correct form of the verbs in brackets.

1 (connect / unplug / plug)

A: The pointer on my screen doesn't move.

B: The mouse and keyboard might not be firmly (1) *connected* to the computer. Try (2) *unplugging* and then (3) *plugging* in the connectors.

2 (have / be / compress)

A: I sent an email with a large attachment that bounced back to me.

B: The receiver may not (4) \_\_\_\_\_ a broadband connection. Or the attachment might (5) \_\_\_\_\_ greater than the size limit of their mailbox. Try (6) \_\_\_\_\_ the attachment.

3 (interfere / change / access)

A: The wireless connection between my router and my computer has stopped working.

B: Somebody may have (7) \_\_\_\_\_ with your user settings. You could (8) \_\_\_\_\_ the username and password for (9) \_\_\_\_\_ your router settings.

2 Write the headings above the right sections of a Consumer Rights website. Then underline the correct words or phrases.

- |  |   |
|--|---|
| a) When you are not covered                | d) Proving goods were faulty when you bought them         |
| b) Goods should be of satisfactory quality | e) Examine goods and complain at once if they are faulty. |
| c) Your agreement is with the retailer     |   |

1 \_\_\_\_\_

If the goods were faulty when you bought them, complain to the retailer, e.g. the store where you bought them. If the store says you (1) *might* / *have to* contact the manufacturer, that's wrong.

2 \_\_\_\_\_

Goods (2) *must* / *may* be of satisfactory quality and fit for the purpose that was intended, e.g. a torch (3) *could* / *should* light up. If you asked about a specific purpose, e.g. 'Will this DVD player work with my brand X TV?', then you (4) *have to* / *can* complain if it doesn't work in that specific situation.

3 \_\_\_\_\_

You (5) *should* / *could* try to examine the goods and complain within a week. If you do this, you

(6) *should* / *can't* get a full refund. If you wait longer than a week, you (7) *must* / *may* not get a refund. Instead you (8) *can't* / *may* be offered a replacement, or a reduction, or a credit note towards your next purchase.

4 \_\_\_\_\_

If you take the goods back to the retailer within six months, the store (9) *has to* / *shouldn't* prove they were not faulty at the time of sale. After six months, you (10) *have to* / *mustn't* prove that they were faulty at the time of sale.

5 \_\_\_\_\_

You (11) *might not* / *cannot* complain if you purchased the goods for the wrong purpose, or if you knew the goods were faulty when you bought them.

## Section 2

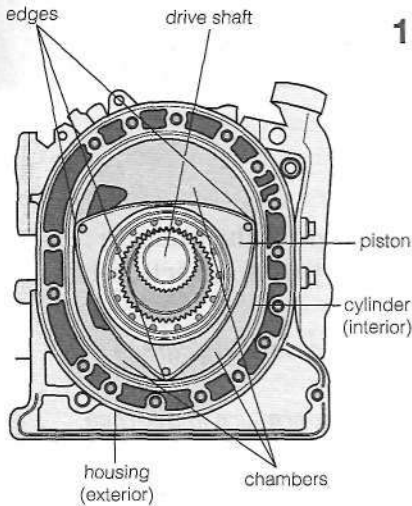

- 1 Complete the description of the Wankel rotary engine with the parts in the diagrams.

A rotary engine is an internal combustion engine with a rotary (1) *piston*. The (2) \_\_\_\_\_ of the rotating piston open and close the ports in the (3) \_\_\_\_\_ wall, so no valves are needed. The triangular piston rotates in an oval-shaped (4) \_\_\_\_\_.

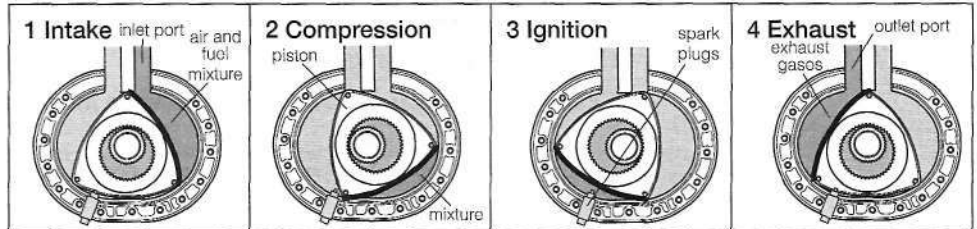

- 1 **Intake.** The rotary piston rotates. *At the same time*, it uncovers the (5) \_\_\_\_\_. This allows the (6) \_\_\_\_\_ to flow into the cylinder.
  - 2 **Compression.** The (7) \_\_\_\_\_ rotates. *At the same time*, the (8) \_\_\_\_\_ is compressed into a small space between the piston and the cylinder wall.
  - 3 **Ignition.** The compressed fuel is ignited by the two (9) \_\_\_\_\_. *Immediately afterwards*, the expanding gases drive the piston round on the power stroke.
  - 4 **Exhaust.** The piston rotates. *Simultaneously*, it uncovers the (10) \_\_\_\_\_. This lets the (11) \_\_\_\_\_ escape.
  - 5 The triangular piston creates three (12) \_\_\_\_\_. So, there are three ignitions for each rotation of the piston.
  - 6 The rotary engine has only two moving parts, the (13) \_\_\_\_\_ and the (14) \_\_\_\_\_. So, higher rotation speeds are possible.
- 2 Rewrite the sentences in paragraphs 1–6 as single sentences. Use *when/as* and *which*. Do not use the words in italics.

Example: 1 *As the rotary piston rotates, it uncovers the inlet port, which allows the air and fuel mixture to flow into the cylinder.*

- 3 Find words in the puzzle to match these definitions.

Y	R	E	F	R	I	G	E	R	A	N	T	G	I	J	A	Z	I	F	A	N
F	E	X	P	A	N	S	I	O	N	V	A	L	V	E	G	C	K	Y	B	O
X	L	P	Q	I	Z	T	R	J	A	S	E	T	O	F	C	O	I	L	S	T
E	V	A	P	O	R	A	T	O	R	K	C	O	M	P	R	E	S	S	O	R
C	O	N	D	E	N	S	E	R	X	M	U	B	T	Q	A	H	N	T	R	H
G	E	D	E	C	O	M	P	R	E	S	S	W	U	E	L	T	W	R	B	G

- |  |  |
|--|--|
| 1 take in, for example, heat or moisture                     | 7 a device that decompresses the refrigerant in the coils                        |
| 2 lower the pressure of something                            | 8 a machine with an electric motor and rotating blades that moves the air around |
| 3 increase in volume   | 9 a fluid that can evaporate and condense  |
| 4 a high-pressure pump that compresses the refrigerant       | 10 a system of pipes bent into a U-shape many times                              |
| 5 a set of coils that gives out heat to the surrounding air  |  |
| 6 a set of coils that extracts heat from the surrounding air |  |

## 1 Sports data

- 1 Describe the purpose of measuring instruments, using one of the example structures and the words in brackets. Use the vocabulary from 4, Section 1 of the Course Book, page 69.

Examples: a) *You use a thermometer to measure temperature in degrees Celsius.*

b) *A thermometer is used for measuring temperature in degrees Celsius.*

c) *A thermometer measures temperature in degrees Celsius.*

d) *You measure temperature in degrees Celsius with a thermometer.*

- 1 (you measure / tyre pressure gauge) *You measure air pressure in psi with a tyre pressure gauge.*
- 2 (is used / kilopascals) \_\_\_\_\_
- 3 (you use / distance) \_\_\_\_\_
- 4 (scales / measure) \_\_\_\_\_
- 5 (you measure / Watts) \_\_\_\_\_
- 6 (you use / stop watch) \_\_\_\_\_
- 7 (measures / speed) \_\_\_\_\_
- 8 (is used / height above sea level) \_\_\_\_\_
- 9 (you measure / beats per second) \_\_\_\_\_

- 2 Complete the details about car service intervals with words from the box.

after always every intervals less than over

If the annual kilometrage (the distance travelled in a year in kilometres) is (1) *less than* 15,000, an **Oil Change Service** should be carried out at (2) \_\_\_\_\_ of 12 months.

An **Inspection Service** (3) \_\_\_\_\_ includes an Oil Change Service.

If the annual kilometrage is (4) \_\_\_\_\_ 30,000, the **Inspection Service** must be carried out (5) \_\_\_\_\_ 30,000 km, and not after 12 months.

A **brake fluid change** is required (6) \_\_\_\_\_ 24 months.

- 3 Read the schedule for servicing petrol engine vehicles. Underline the right verbs.

What is included in a service	
<b>Oil Change Service</b> 1 Oil filter lubricated / <u>renewed</u> . 2 Engine oil changed / inspected. 3 Brake pad thickness renewed / checked.	<b>In addition (every 30,000 km)</b> 7 V-belt checked and torsioned / loosened if necessary.
<b>Inspection Service (in addition)</b> 4 Door check straps cleaned / lubricated. 5 Exhaust system inspected / cleaned. 6 Coolant in radiator topped up / measured.	<b>In addition (every 60,000 km)</b> 8 Spark plugs tightened / renewed. 9 Air filter renewed / topped up. 10 Air filter housing cleaned / replaced.

## 2 Sensors

1  21 Note the answers to these questions about car safety tests.

- 1 How safe were the cars in 1997? \_\_\_\_\_
- 2 What safety features did they have in 1997? \_\_\_\_\_
- 3 What do you mean by 'marginal'? \_\_\_\_\_
- 4 Is one-star better or worse than five-star? \_\_\_\_\_
- 5 Are cars safer now than they used to be? \_\_\_\_\_

2  22-24 Listen to three parts of an interview about car safety. Fill in the tables.

1997		Airbags			
Model	None	Driver's	Dual	Safety rating (circle)	
1	Hydra				poor / marginal / acceptable / good
2	Lindos				poor / marginal / acceptable / good
3	Paxos				poor / marginal / acceptable / good
4	Syros				poor / marginal / acceptable / good

2000		Airbags			
Model	None	Driver's	Dual	Safety rating (circle)	
1	Lorca				* / ** / *** / ****
2	Pamplona				* / ** / *** / ****
3	Malaga				* / ** / *** / ****
4	Zamora				* / ** / *** / ****

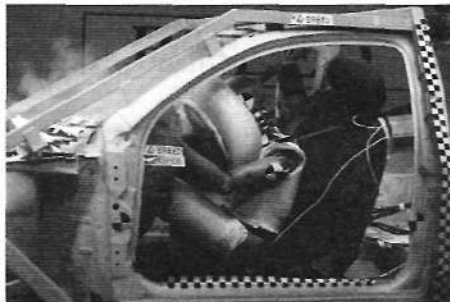

2007	Number of small car models tested:	8
	Models with front, side and head airbags:	
	Models with driver's airbag only:	
	Models with three-star safety rating:	
	Models with four-star safety rating:	
	Models with five-star safety rating:	

3 Write noun combinations for the phrases.

- 1 forces that squeeze one side of a material and stretch the other *bending forces*
- 2 forces that squeeze or press together \_\_\_\_\_
- 3 forces that stretch or pull apart \_\_\_\_\_
- 4 forces that twist \_\_\_\_\_
- 5 forces that slide in opposite directions \_\_\_\_\_
- 6 a crash test of a heavy goods vehicle \_\_\_\_\_
- 7 a dummy used for testing the impact of a crash from the side  
\_\_\_\_\_
- 8 a sensor which measures acceleration in a single direction  
\_\_\_\_\_

### 3 Positioning

1 Read the text. Choose the best words/phrases for the gaps.



#### What is a lidar speed gun?

Lidar stands for 'light detection and ranging'. A lidar speed gun sends out a very short burst of infrared laser light. It is used by the police to calculate speeds.

#### How does the lidar system work?

Light from the gun travels at (1) \_\_\_\_\_ 300 million metres per second and is reflected back to the speed gun by the vehicle. The gun calculates the time taken for the return trip of the signal and divides it in two. (2) \_\_\_\_\_, it can calculate its distance from the car.

#### How does the speed gun calculate the speed of an approaching vehicle?

Because the speed gun takes (3) \_\_\_\_\_ 1,000 samples per second, it can compare the change in distance between the samples and (4) \_\_\_\_\_ calculate the speed of the vehicle.

#### How accurate is the lidar system?

Since it takes (5) \_\_\_\_\_ 300 measurements in a third of a second, the measurement of a vehicle's speed is very accurate. (6) \_\_\_\_\_, the cone of light that comes from the speed gun is very narrow. Even at a range of 300 metres, the cone of light is no more than 1 metre in diameter.

(7) \_\_\_\_\_, a specific vehicle can be targeted by the police from long range.

- |   |                   |                 |                   |
|---|-------------------|-----------------|-------------------|
| 1 | a) nearly         | b) exact        | c) approximate    |
| 2 | a) In other words | b) In addition  | c) For example    |
| 3 | a) in addition    | b) for instance | c) more than      |
| 4 | a) more than      | b) in this way  | c) nearly         |
| 5 | a) just over      | b) for example  | c) in addition    |
| 6 | a) However        | b) In addition  | c) In other words |
| 7 | a) In this way    | b) That is      | c) For instance   |

2 Replace the phrases using the word(s) in brackets.

An airport radar control system sends out a burst of high-frequency radio waves, which lasts less than a microsecond. The radar system then turns off its transmitter, turns on its receiver and listens for an echo. For each aircraft in the area, the Air Traffic Controller can monitor:

- 1 their location (where) *where they are*
- 2 their altitude above sea level (how) *how high* \_\_\_\_\_
- 3 their air speed (how fast / fly) \_\_\_\_\_
- 4 their rate of descent (how fast / descend) \_\_\_\_\_
- 5 their rate of ascent (fast / ascend) \_\_\_\_\_
- 6 their separation distance from other aircraft (how far apart) \_\_\_\_\_
- 7 their flight path (which direction / fly) \_\_\_\_\_
- 8 their distance from the airport (how far away) \_\_\_\_\_

## 4 Word list

MEASUREMENT (NOUNS)	SENSORS (NOUNS)	POSITIONING (NOUNS)	ADVERBS
altimeter	accelerometer	burst	almost
altitude	bass volume	Global Positioning System (GPS)	approximately
athlete	chest	latitude	exactly
barometer	data	lidar system	just over
chain	deflection	longitude	just under
compete	deformation	nautical mile	more than
cyclist	dial	ping	nearly
false start	dummy	pinger	wirelessly
filter	environment	radar system	<b>ADJECTIVES</b>
heart rate monitor	gauge	satellite	atmospheric
heart beat	impact	sea level	precise
kilopascal	load	transmission	quick-release
lubricant	rib	<b>VERBS</b>	standard
odometer	sensor	approach	worn
power output	shear	multiply	<b>PHRASES</b>
saddle	strain	orbit	for example
scales	tension	reflect	for instance
stop watch	torsion	subtract	in addition
tachometer	<b>VERBS</b>	<b>VERBS (OTHER)</b>	in other words
tennis ball service	bend	apply	such as
wear	convert	ensure	that is
WebLog	detect	lubricate	
wheel rim	squeeze	slip	

1 Complete these descriptions using words from the Word list.

- 1 An **altimeter** measures *altitude* in metres above \_\_\_\_\_. It measures the air pressure in units called \_\_\_\_\_.
- 2 A **GPS system** calculates your position, or in other words your \_\_\_\_\_ and \_\_\_\_\_. It measures the \_\_\_\_\_ times from at least three \_\_\_\_\_, which \_\_\_\_\_ the Earth at an \_\_\_\_\_ of 11,000 \_\_\_\_\_.
- 3 A **radar gun** at tennis competitions uses the \_\_\_\_\_. The radar gun is pointed at the tennis player and takes many readings as the tennis ball \_\_\_\_\_. From this it calculates the speed of the \_\_\_\_\_.
- 4 A **radar system** can \_\_\_\_\_ planes in flight as they \_\_\_\_\_ the airport. The \_\_\_\_\_ transmits a short \_\_\_\_\_ of high-frequency radio waves. When the signal is \_\_\_\_\_ back to the receiver, the system can measure the speed of the \_\_\_\_\_ plane and its distance from the airport.



## 1 Properties

1 Choose the right test from the box. Make sentences, using the past tense and the given words.

compressive-strength / drop / elasticity / frame / impact-resistance / heat-resistance / tensile strength

- 1 aim / see / forks / bend / when / struck with force  
*The aim of the frame test was to see whether the forks would bend when they were struck with force.*
- 2 purpose / find out / material / deform or break / when / pulled apart
- 3 aim / discover / material / bend or break / when / hammered with force
- 4 objective / find out / material / crack or deform / when / compressed
- 5 purpose / discover / materials / break / when / stretched
- 6 aim / find out / material / deform or melt / when / heated to 120 degrees Celsius
- 7 objective / see / laptops / crack / when / dropped from a height of 60 cm

2 Complete the crossword.

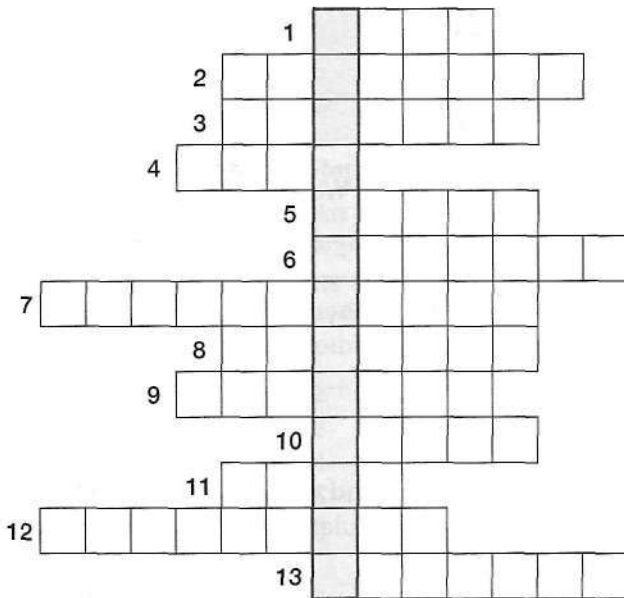

Vertical word: It doesn't burn or deform when you heat it. It's \_\_\_\_\_.

- 1 You can't scratch or cut it. It's \_\_\_\_\_.
- 2 You can bend it and it doesn't break. It's \_\_\_\_\_.
- 3 You can form it into a new shape, which it keeps. It's \_\_\_\_\_.
- 4 Opposite of hard.
- 5 You can't bend it. It's \_\_\_\_\_.
- 6 After you deform it, it returns to its original shape. It's \_\_\_\_\_.
- 7 It doesn't deform or break when you compress it. It's strong in \_\_\_\_\_.
- 8 It breaks if you strike or drop it. It's \_\_\_\_\_.
- 9 It doesn't stretch or break when you pull it. It's strong in \_\_\_\_\_.
- 10 It doesn't break when you drop or strike it. It's \_\_\_\_\_.
- 11 Opposite of strong.
- 12 It doesn't break or deform when you twist it. It has \_\_\_\_\_ strength.
- 13 It doesn't deform or break when you pull it apart. It has \_\_\_\_\_ strength.

## 2 Resistance

1 25 Underline the stressed syllables. Then listen and check.

- |                      |                |                  |
|----------------------|----------------|------------------|
| 1 <u>break</u> a ble | 2 in au di ble | 3 por ta ble     |
| 4 re sis tant        | 5 e las tic    | 6 un mo vea ble  |
| 7 un bend a ble      | 8 wa ter proof | 9 com bus ti ble |
| 10 cor ro sion       |                |                  |

2 26 Listen to four radio adverts. Tick the product descriptions.

	1 digital camera	2 diver's watch	3 home safe	4 biker's helmet
portable	✓	✓		✓
non-portable				
non-combustible				
unbreakable				
waterproof				
heat-resistant				
corrosion-resistant				

3 27 Choose signpost phrases from the box for a presentation about flood defences. Then listen and check.

- |  |                                  |
|--|----------------------------------|
| a) My objective in this talk has been to   | f) I'd like to finish by         |
| b) As you can see in this photo            | g) the next graph indicates that |
| c) Let's move on to                        | h) As shown on the first graph   |
| d) The main aim of this presentation is to | i) I'd like to start by          |
| e) That brings me to                       |                                  |

	Phrase	Presentation notes
1	<i>d</i>	discuss danger to _____ of flooding + examine topic of _____
2		3 main causes of flooding: 1) _____ in _____; 2) tides from _____; 3) _____ of southeast England
3		1970s banks of River Thames raised by _____. Below London _____ of flood defences. Above London, _____ of river banks raised.
4		Thames Barrier, huge _____ flood barrier built in _____
5		10 _____ gates, _____ + supported between concrete _____ When closed, barrier can withstand pressure of _____
6		2001 IPCC report predicts annual rise of < _____ = rise of > _____ by end of century
7		1993-2006 sea levels rose by _____ average = rise of < _____ by end of century
8		_____ factors > flooding, + _____ effects + _____ methods of flood prevention
9		map of areas of London below _____ by _____

4 Listen again and complete the presentation notes in Exercise 3.



### 3 Results

#### 1 Choose the right words/phrases of cause and effect.

##### Global warming will happen faster

Increased carbon emissions since 1850 have raised the percentage of CO<sub>2</sub> in the atmosphere, which (1) *causes/ results* global warming. The forest fires in Asia, Europe and the USA in 2007 increased carbon emissions further. (2) *So/ As* atmospheric temperatures rise, this is causing the ice at the poles to melt much faster than we once thought.

We now understand how and why icecaps melt so fast. (3) *As/ Therefore* meltwater runs down to the base of the icecaps, parts of them slip and fall into the sea as icebergs. Pools of water form on the surface. (4) *Since/ So* this makes the ice darker, (5) *it therefore/ so* absorbs more heat. This is already happening in Greenland and West Antarctica.

(6) *Since/ As a result* of these changes, the icecaps will melt faster than expected. The rising sea level will (7) *lead/ result* in drowning many of the world's most crowded cities. In addition, this could (8) *lead/ bring* to much higher rises in global temperature, (9) *then/ because* less heat from the sun is reflected back into space by the reduced icecaps.

About 3.5 million years ago, temperatures increased to 2–3 degrees above today's level. (10) *As a result/ Therefore*, sea levels rose by 25 metres, which is far above the present forecast of 59 centimetres.

So, how can we reduce carbon emissions? One study recommends linking the electricity networks of Europe, North Africa and Iceland with high voltage DC cables. This would provide a greater choice of renewable power. (11) *As a result/ Because*, every country in the network could (12) *then/ as* use hydroelectricity from Scandinavia and the Alps, geothermal power from Iceland and electricity from new solar thermal power plants in the Sahara.

#### 2 Answer the questions.

- 1 What causes global warming?
- 2 When did the increase in carbon emissions start?
- 3 Are the icecaps melting faster or slower than forecast?
- 4 What name is given to the water that comes from melting snow and ice?
- 5 Why does water absorb more heat than ice?
- 6 How do large icecaps act against global warming?
- 7 Will sea levels rise more or less than the earlier forecast?
- 8 What three kinds of energy can be produced in Africa, Europe and Iceland?

#### 3 Use verbs from the box in their right form to complete the text.

flatten harden harden heat lengthen sharpen sharpen sharpen soften



##### How swords are made

First a piece of steel is (1) *heated* and (2) \_\_\_\_\_ in a furnace. The steel becomes red hot at about 650 to 820 degrees Celsius and orange at just under 1,000 degrees Celsius.

After the piece of steel is (3) \_\_\_\_\_, it is (4) \_\_\_\_\_ and (5) \_\_\_\_\_ by hammering into the basic sword shape.

Next, the piece of steel is (6) \_\_\_\_\_ at one end to create the sword tip.

Finally, before the grinding and polishing stage, the blade must be annealed, or (7) \_\_\_\_\_, so that it is easier to (8) \_\_\_\_\_. After the blade is (9) \_\_\_\_\_, it must be (10) \_\_\_\_\_ again. It is therefore placed in a hot salt bath for a period of time. At the end of this stage, it is put in a quench tank, which cools the blade rapidly and also (11) \_\_\_\_\_ it.

## 4 Word list

PROPERTIES (NOUNS)	PROPERTIES (ADJECTIVES)	RESISTANCE (ADJECTIVES)	RESULTS (NOUNS)
aim	compressive	breakable	bio-gas
bending	destructive	combustible	carbon
compression	elastic	inaudible (1)	carbon emission
compressive	plastic	moveable	earth
deformation	tensile	non-combustible	hull plate
ductility	<b>RESISTANCE (NOUNS)</b>	non-portable	hydrogen
elasticity		perishable	iceberg
flexibility	cross brace	resistant	Richter scale
impact-resistance	damper	scratch-proof	rivet
investigation	damping	unbreakable	rivet head
load	earthquake	unmoveable	shock
newton	graph	waterproof	slag
objective	high-rise building	<b>ADVERBS</b>	<b>RESULTS (VERBS)</b>
plasticity	impact	apart	darken
procedure	isolation	<b>PHRASES FOR CAUSE &amp; EFFECT</b>	fail
rigidity	joint		flatten
shearing	shear wall	as	forge
tensile strength	single brace	as a result	harden
tension	truss	and so	install
torsion	<b>RESISTANCE (VERBS)</b>	because	lengthen
yield point		since	lighten
<b>PROPERTIES (VERBS)</b>	isolate	therefore	sharpen
	resist		shorten
deform	<b>RESULTS (ADJECTIVES)</b>		soften
hammer		straighten (6)	
indicate	earthed		strengthen
specify	live		weaken
withstand	neutral		widen

1 Find adjectives in the Word list that mean the opposite.

1 audible 2 breakable 3 combustible 4 moveable 5 portable

2 Find verbs in the Word list that mean the opposite.

6 bend 7 darken 8 narrow 9 shorten 10 soften 11 succeed  
12 weaken

## Section 1

1 Read the text about sonar and tick the right columns in the table.

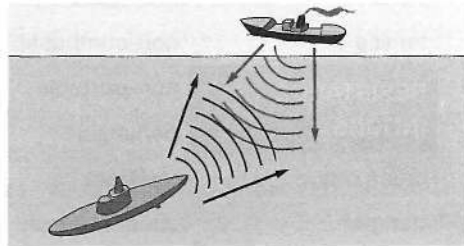

active sonar

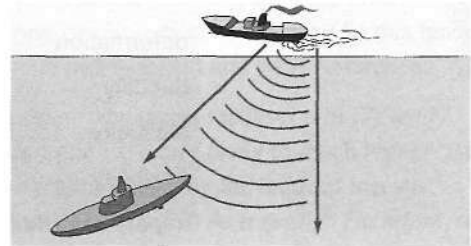

passive sonar

**How sonar<sup>(1)</sup> works**

Active sonar sends out a burst of sound, or 'ping', which travels through the water, reflects off the target and returns to the ship.

To find out the distance to the target, the sonar system measures the time from transmission to reception. Since the system knows the speed of sound in water, which is 1,500 metres per second, it can calculate the distance.

To measure the bearing of the object, i.e. in which direction it is, a multi-beam system is used. The echoes that are reflected back are processed by computer to locate the target, but cannot identify it. However, in war, the sound of a ping made by a submarine immediately shows the enemy its own location, which may be dangerous.

These days, fishing vessels use active sonar to detect and locate fish, since sound waves travel differently through fish than through water. When active sonar is used to measure the depth of water between the vessel's transducer and the seabed, this is known as 'echo sounding'.

Passive sonar listens to sounds generated by the target. A computer system helps the operator to identify the vessel type, its distance, course and speed, and even the ship itself. Computer-assisted displays are similar to above-ground radar displays.

Passive sonar has several advantages. It is silent. It has a greater range than active sonar. It allows the user to identify the target. However, it requires expensive equipment and is more costly than an active sonar system.

<sup>(1)</sup> sonar = sound navigation and ranging

	Features	Active sonar	Passive sonar
1	Transmits and receives signals		
2	Receives signals only		
3	Used to find out distance to target and its bearing		
4	Used to identify a vessel		
5	Used for fishing and measuring the depth of the water		
6	More expensive, but works at longer distances		
7	Noisier, and more dangerous to use in a war		

## Section 2

### 1 Match the words with their definitions.

break breaking point clamp crack deform secure withstand yield point

- 1 to change shape *deform*
- 2 the point where a material breaks \_\_\_\_\_
- 3 to resist \_\_\_\_\_
- 4 the point where a material deforms \_\_\_\_\_
- 5 to separate into two or more pieces \_\_\_\_\_
- 6 to hold firmly \_\_\_\_\_
- 7 to break so that surface lines appear \_\_\_\_\_
- 8 a tool for holding something firmly \_\_\_\_\_

### 2 Complete the engineer's report with verbs from the box and 'should'.

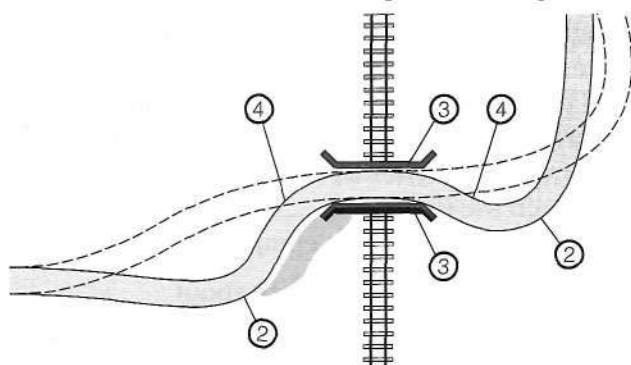

lengthen straighten strengthen widen

- 1 Road improvements are recommended for this accident 'black spot'.
- 2 The road is too narrow and has sharp corners. It should be \_\_\_\_\_ and \_\_\_\_\_.
- 3 The side walls on the bridge are not strong enough. They \_\_\_\_\_.
- 4 The approach roads on both sides are too short and steep. Therefore they \_\_\_\_\_.

### 3 Match the cause and effect. Then combine the sentences using the word/phrase in brackets.

Example: 1 *The old cables were taken out, and new wiring was installed last year, and as a result the number of electrical accidents has fallen to zero.*

- |  |  |
|--|--|
| 1 The old cables were taken out, and new wiring was installed last year. (and as a result) | a) The air-sea rescue team were able to locate its position very quickly.    |
| 2 Concrete horizontal decks were placed under the floors five years ago. (and so)          | b) The company will start to manufacture the sports car early next year.     |
| 3 All our diesel engines were replaced two years ago with hydrogen engines. (As a result)  | c) We have decided to use titanium instead of aluminium.                     |
| 4 The frame of the new bike has failed the compression and rigidity tests. (Therefore)     | d) The number of electrical accidents has fallen to zero.                    |
| 5 The captain of the damaged sailing boat had a GPS system on board. (Since)               | e) The building resisted yesterday's earthquake at 8.4 on the Richter scale. |
| 6 The crash-testing of the new model was 100 percent successful. (As)                      | f) Carbon emissions in the city have gone down by over 50 percent.           |

### 4 Underline the stressed syllables.

de <u>form</u>	de struc <u>tive</u>	e las <u>tic</u>	e mis <u>sion</u>	flex i bil i <u>ty</u>	
in di <u>cate</u>	i so <u>late</u>	i so la <u>tion</u>	ob jec <u>tive</u>	re <u>sist</u>	
ri <u>gid</u>	ri gi di <u>ty</u>	spe ci <u>fy</u>	ten <u>sion</u>	tor <u>sion</u>	with <u>stand</u>

## 1 Working robots

1 Complete the text with words from the box.

compressed dangerous different electric mechanical mobile remote repeated specific

Robots are machines that are guided by (1) *mechanical* and electronic means. They carry out functions that may be (2) \_\_\_\_\_, heavy-duty, unhealthy, or ones that are (3) \_\_\_\_\_ many times. Robots run on (4) \_\_\_\_\_ motors, (5) \_\_\_\_\_ air, sensors and computer systems. Some are fixed, and others are (6) \_\_\_\_\_.

Some robots are operated by (7) \_\_\_\_\_ control, as in undersea or space exploration. Other robots are set up to do their tasks by a 'teach-and-repeat' method. For example, an operator teaches a robot a (8) \_\_\_\_\_ job by moving the robot's arm through the (9) \_\_\_\_\_ positions. The positioning data is recorded and stored in the robot's computer memory.

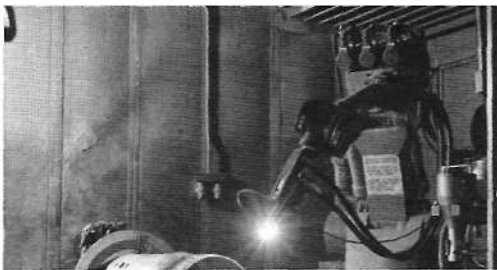

2 Write the headings above the six texts about working robots.

- a) Painting      b) Handling      c) Welding<sup>(1)</sup>  
 d) Palletising<sup>(2)</sup>      e) Finishing      f) Cutting

<sup>(1)</sup> joining two pieces of metal together

<sup>(2)</sup> placing heavy things on a large wooden frame for storage

<p>1 _____                      Car assembly plants have used robots for many years as this process produces dangerous fumes and bright lights. Robot arms have to carry a weld gun that can weigh over 100 kg.</p>	<p>2 _____                      This was an early application of robots, as the process produces harmful, flammable fumes as the paint evaporates. The robots have quite thin arms as they don't have to carry much weight.</p>
<p>3 _____                      Robots are a good choice as the process can involve dangerous technologies. The robot holds either the part or the cutting tool.</p>	<p>4 _____                      With a six-axis robot, you can finish parts in all kinds of materials. The robot holds either the part or the tool. You can also use a multi-purpose tool at the end of the robot arm.</p>
<p>5 _____                      Robots have the power and speed for this kind of job. They can move car parts, eggs, chocolates, bottles of drinks, and loads up to 120 kg. They can perform at rates of 150 picks per minute.</p>	<p>6 _____                      As an example, a robot picks up bags of cement and places them on a pallet. It counts the bags and knows where the next one must be placed. Simpler four- or five-axis robots can be used, e.g. for palletising foods or building materials.</p>

## 2 Eco-friendly planes

### 1 Complete the text with words from the box.

drag engines engines friction gravity lift lift pressure thrust thrust  
weight wing wing

During flight, air flows over the top of the curved (1) *wing* faster and with less pressure than the air flowing under the wing. The greater (2) \_\_\_\_\_ of the air under the wing creates (3) \_\_\_\_\_. If the lift is greater than the earth's (4) \_\_\_\_\_, the plane will fly. Moveable slats at the front of the (5) \_\_\_\_\_, and moveable flaps at the rear and underside increase the wing surface area at take-off and landing. In this way, they increase the (6) \_\_\_\_\_ force at slow speeds.

Drag is caused by (7) \_\_\_\_\_ as the plane moves through the air. (8) \_\_\_\_\_ slows the plane. To keep the plane moving forwards, the plane uses propellers or jet engines. These turboprop or turbojet (9) \_\_\_\_\_ provide (10) \_\_\_\_\_, which pushes the plane forwards.

In a glider, there are no (11) \_\_\_\_\_ which push the air backwards. In other words, there is no forwards (12) \_\_\_\_\_. Lift is provided by air passing over its wings. It also uses a rising current of warm air (thermal) to help it ascend. If the lift is less than the (13) \_\_\_\_\_ of the glider, the glider will lose altitude.

### 2 Read the text about an eco-friendly plane. Complete the table with 'YES/NO'.

The design brief for the F11 came from a need for a small business aircraft. By the 1990s, business travel in Europe had serious problems. Business jets were too expensive. They needed long runways, so they could only use the main airports. Because business people had to take scheduled flights, they wasted a lot of time. First, they had to travel to a major airport. Then there were frequent delays at the airport and in the air.

A survey showed that 97 percent of business people travel only in groups of 1–3, so clearly there was a need for a small air taxi. It also showed that there were 5,000 small airfields in the US and 2,000 in Europe. In addition, 90 percent of the population in the USA and the UK live within a 20-minute drive of their local airport.

The proposed aircraft had to fly slowly enough to land on small airfields, but fast enough to compete with airlines (650 kph). The solution was a six-seater aircraft, with a turboprop engine, since safety rules now allowed passenger aircraft to have a single engine. Over 300 wing designs were examined before developing one with reduced drag and lower fuel consumption.

Comparative survey results	business jet	airline	turboprop taxi
Point-to-point travel (near client's base)	NO		
Reasonable prices			
Need long runway			
Delays when using major airports			



### 3 Free-flying sails

1  28 You are going to listen to a talk about a catamaran ferry. Put the signpost phrases from the box in the correct place in the table. Then listen and check.

- |  |  |
|--|--|
| a) Let's talk about performance data.            | f) Finally, I should mention some disadvantages. |
| b) I'd like to start by asking you a question.   | g) That brings me to the design.                 |
| c) I'd like to move on to the dimensions.        | h) The aim of this talk is to ...                |
| d) I'd like to finish by showing you this graph. | i) So, was there a problem with the design?      |
| e) Now let's look at the load.                   | j) Let's turn to some of the advantages.         |

	Phrase	Presentation notes
1	<i>h</i>	<i>Aim: Examine difference between monohull ferries and multi-hull ferries.</i>
2		<i>Question: How old is the catamaran design? First used by fishermen in _____ ago. Later, design spread through _____.</i>
3		<i>Two _____, joined together by a _____. Sporting/commercial catamarans built for past _____, e.g. large ferries: two hulls, each powered by _____.</i>
4		<i>Catamaran design. _____ and _____. Their _____ is better. Go fastest when waves are small.</i>
5		<i>Dimensions. _____ long; _____ wide; depth of _____ in the water.</i>
6		<i>Load. HSS 1500. _____ passengers and _____ cars. HSS 900. _____ passengers and _____ cars.</i>
7		<i>Performance data. HSS 1500: in-service speed _____, _____ max. HSS 900 is _____.</i>
8		<i>Problem. Material used for the _____, a type of _____.</i>
9		<i>Disadvantages. _____ cost. More expensive to build a _____ ferry than a _____ ferry. Also _____ costs.</i>
10		<i>Graph. Compares fuel costs. More expensive to run 1 _____ ferry than to run 7 _____ ferries. Fuel costs certain to _____, not _____, in future.</i>

2 Listen again and fill in the gaps in the notes in Exercise 1.

3 Match the nouns in the box with nouns of the same meaning.

aim brief client components data dimensions drawback issue operation signpost



1 parts _____	6 working _____
2 disadvantage _____	7 measurements _____
3 facts _____	8 question _____
4 objective _____	9 indication _____
5 customer _____	10 instructions _____

## 4 Word list

NOUNS (robots)	NOUNS (planes)	NOUNS (kites)	VERBS (robots)
advantage	atmosphere	balloon	conduct
convention	consumption	bookmark	improve
disadvantage	design brief	bow	suggest
drawback	drag	capsule	VERBS (planes)
frequency	environment	cargo	combine
girder	friction	click wheel	consume
majority	fuselage	client	emit
participant	gravity	cruise control	expel
survey	greenhouse gas	data	perform
TV remote	issue	diesel oil	reduce
weakness	jet turbine	helium	taper
ADJECTIVES (all)	lampshade	horse power	trigger
ambitious	lift	jack	VERBS (kites)
automatic	noise level	living quarters	maximise
compact	pollution	mast	mention
current	resource	mooring bit	propose
curved	strut	polymer	scroll
eco-friendly	technology	routing	untie
environmental	thrust	stability	
industrial	wingspan	stainless steel	
leather	wingtip	supertanker	
multi-functional	ADVERBS (all)	touchscreen	
multi-touch	arguably	traction kite	
navigational	permanently	trimming	
noisy	smoothly	USB connector	
non-renewable	technically	USB docking port	
pressure-resistant	upwards	voicemail	
voice-activated			

### 1 Complete the sentences with verbs from the Word list.

- We should \_\_\_\_\_ a survey.
- The design must be \_\_\_\_\_.
- They need to \_\_\_\_\_ noise levels.
- \_\_\_\_\_ the cable from the mooring bit now.
- A long wingspan should \_\_\_\_\_ lift.
- Planes \_\_\_\_\_ greenhouse gases.
- Ships \_\_\_\_\_ a lot of diesel oil.
- I'll now \_\_\_\_\_ some advantages.

## 1 Zero emission

- 1 Add the headings in the box to the sections. Then underline the right verbs to complete the press release about a hybrid car.

Advantages Components Need Problems Solution Technology

- 1 **Need.** Greenhouse gas emissions, e.g. CO<sub>2</sub> and nitrous oxide, must be (1) reduced / improved to avoid global warming. Petrol engines (2) absorb / consume too much fossil fuel.
- 2 \_\_\_\_\_ . Electric-only vehicles can be (3) used / generated, but their batteries are too heavy and their range is too limited.
- 3 \_\_\_\_\_ . Hybrid cars (4) propose / combine a petrol engine and an electric motor into one system. The motor (5) performs / provides high torque in the low rpm range, while the engine (6) delivers / propels extra power at the higher rpm range.
- 4 \_\_\_\_\_ . The hybrid car is (7) based / solved on two technologies, the gas/petrol engine, and the electric motor, with generator and battery.
- 5 \_\_\_\_\_ . Hybrids (8) withstand / emit less CO<sub>2</sub> than petrol vehicles. The engine can (9) run / transmit on gas, petrol or bio-fuel. The battery (10) recharges / generates itself, so no extra electrical cables are needed.
- 6 \_\_\_\_\_ . The battery is (11) suspended / positioned between the two rear wheels. The generator and inverter/converter are (12) located / mounted beneath the floor and provide power for the electric motor. They also recharge the battery when required. The petrol engine and the electric motor are (13) located / mounted onto the chassis. The power split device is placed next to the engine. This transfers part of the power (14) consumed / produced by the engine to drive the wheels, and the rest to the generator, either to (15) recharge / maximise the battery or to (16) power / increase the electric motor.

- 2 Label the diagram with words from the box.

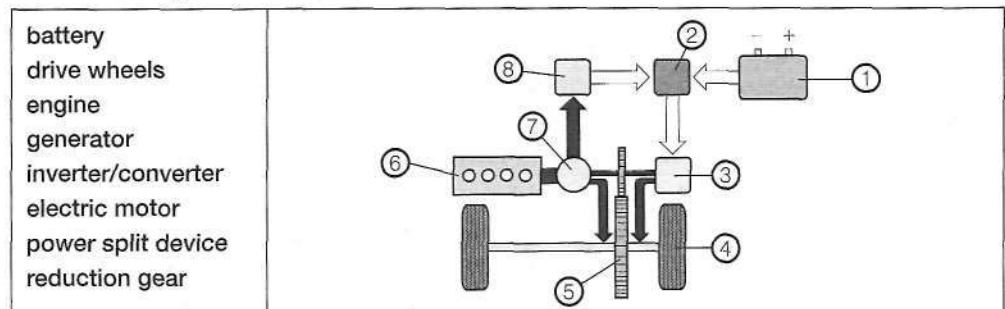

## 2 Technological change

1 Write the words/phrases in the box on the right lines.

abacus boiler compass crane crank and rod hydraulic jack  
pulley and belt robot spectacles wedge wind turbine windmill

- 1 Tools: *abacus* \_\_\_\_\_
- 2 Simple machines: \_\_\_\_\_
- 3 Heavy machine tools: \_\_\_\_\_
- 4 Self-running machines: \_\_\_\_\_

2 Match words from Exercise 1 with these definitions.

- 1 a machine that can use tools and is controlled by a computer *robot*
- 2 a machine that turns in the wind and generates electricity, or grinds corn  
\_\_\_\_\_
- 3 a machine that is used to provide heating or hot water \_\_\_\_\_
- 4 a rod attached to a wheel which rotates when the rod moves backwards and forwards \_\_\_\_\_
- 5 a frame with two lenses worn over the eyes to help you see \_\_\_\_\_
- 6 a large tall machine used by builders for lifting very heavy things  
\_\_\_\_\_
- 7 a hand-held device used for calculating \_\_\_\_\_
- 8 an instrument that shows directions and the north point \_\_\_\_\_
- 9 a machine that turns in the wind and generates electricity \_\_\_\_\_
- 10 a machine with a wheel over which a belt, rope or chain passes  
\_\_\_\_\_
- 11 a piece of wood or metal with one thick edge and one pointed edge  
\_\_\_\_\_
- 12 a tool for lifting a heavy weight off the ground and supporting it in the air  
\_\_\_\_\_

3 Write a paragraph about a waterwheel, using the guide words.

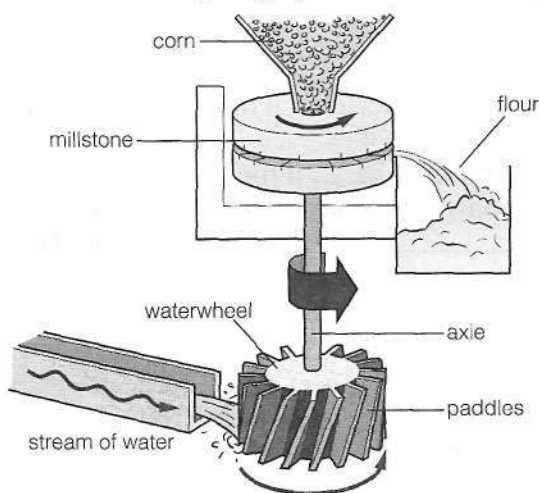

earliest - waterwheel - made - Greece  
- 2,000 years ago / made - wood /  
consisted - horizontal wheel - rotated -  
when - stream of water - hit - paddles /  
force - water - made - wheel - attached  
axle - rotate /  
axle - attached - waterwheel - one end  
- circular millstone - other /  
millstone - rotated - grind - corn - flour  
/ Later - vertical waterwheels - used /  
These - could - built - greater size - with  
- greater power /

*Example: The earliest waterwheel was made in Greece 2,000 years ago.*

### 3 Vehicle safety

- 1  29 Listen to the interview between a TV journalist and a car safety expert. Delete any questions on the list that the journalist doesn't ask.

#### Questions about tyre sensors

- 1 name of invention: \_\_\_\_\_
- 2 name of inventor: \_\_\_\_\_
- 3 function or purpose: \_\_\_\_\_
- 4 need: \_\_\_\_\_
- 5 technology / principle: \_\_\_\_\_
- 6 main parts / features: \_\_\_\_\_
- 7 location of parts: \_\_\_\_\_
- 8 operation / how they work: \_\_\_\_\_
- 9 advantages: \_\_\_\_\_
- 10 disadvantages: \_\_\_\_\_

- 2 Listen to the interview again. Note the main points of the expert's answers in the checklist.
- 3 Complete the sentences about the functions of sensors with verbs from the box.

activate allow contain detect ensure give prevent provide report send

- 1 Current vehicles *contain* 50–100 sensors and this number is continually growing.
- 2 These sensors \_\_\_\_\_ vehicles to listen and react to the environment around them.
- 3 Electronic sensors \_\_\_\_\_ that new vehicles are the safest cars on the road.
- 4 Quick-reaction crash sensors \_\_\_\_\_ the airbags and the tension on the seatbelt.
- 5 Outside temperature sensors \_\_\_\_\_ a signal when there is a risk of ice.
- 6 Engine management system sensors \_\_\_\_\_ information on exhaust gas quality.
- 7 Seat occupancy detectors \_\_\_\_\_ the passenger seat airbags from opening in the event of an accident if the seat is empty or if a child's seat is fitted.
- 8 Acceleration sensors \_\_\_\_\_ if the vehicle is lifting off its vertical axis and if it needs to apply the brakes to one, two or three wheels.
- 9 Height sensors \_\_\_\_\_ approaching vehicles and automatically adjust the headlamps to prevent oncoming drivers from being blinded.
- 10 When combined with the Global Positioning System (GPS), sensors \_\_\_\_\_ the driver his or her location.

## 4 Word list

NOUNS (zero emission)	NOUNS (technological change)	NOUNS (simple machines)	VERBS (all)
air conditioner	abacus	cam and follower	accelerate
capacitor	align	crank and rod	craft
deceleration	ancestor	gear	cruise
fossil fuel	axe	lever	focus
fuel cell	balance scales	pulley and belt	gain
luggage space	bead	rack and pinion	harvest
methane	calculation	ratchet and pawl	idle
nitrous oxide	cart	screw	position
output	compass	wedge	recover
startup	copper	wheel and axle	release
torque	craftsman	<b>NOUNS (drilling)</b>	split
ultra-capacitor	flint	derrick	tame
zero-emission	harness	drill bit	<b>ADJECTIVES (all)</b>
<b>NOUNS (vehicle safety)</b>	hydraulic jack	drill string	accurate
	lens	fibre-optic cable	automotive
career	lever	irrigation	compressed
diploma	magnetic pole	laser	lightweight
factsheet	mallet	mining	magnetic
invention	manufacture	percussion drilling	mass-produced
inventor	pan	rotation	mathematical
journalist	pencil	tripod	productive
press release	pulley		rotary
principle	pyramid		
	scythe		
	spectacles		
	windmill		

1 Find words from the Word list that mean the opposite.

- 1 decelerate \_\_\_\_\_
- 2 grip \_\_\_\_\_
- 3 hand-crafted \_\_\_\_\_
- 4 heavyweight \_\_\_\_\_
- 5 input \_\_\_\_\_
- 6 lose \_\_\_\_\_
- 7 pollution \_\_\_\_\_

## Section 1

- 1 Complete the dialogue about using SAT NAV (satellite navigation) for car journeys.

advantages could could disadvantages drawbacks improve should strength suggest suggest weakness would

A: So what are the main (1) *advantages* of using SAT NAV?

B: Well, its main (2) \_\_\_\_\_ is that you can listen to the directions if you are travelling alone.

A: So would you say it has any (3) \_\_\_\_\_ or (4) \_\_\_\_\_?

B: Yes, its main (5) \_\_\_\_\_ is that SAT NAV routes don't include height restriction details. If you are driving a high vehicle, you may end up on a narrow road with a low bridge in front of you, where you can't turn round. It happens all the time.

A: So, how (6) \_\_\_\_\_ you (7) \_\_\_\_\_ that it (8) \_\_\_\_\_ be improved in future?

B: Well, I would (9) \_\_\_\_\_ that all SAT NAV routes (10) \_\_\_\_\_ include data like low bridges and narrow roads. Meanwhile, if you are travelling with a passenger, you (11) \_\_\_\_\_ ask them to map-read for you.

A: Really? Why not use the latest technology?

B: Because it needs to be (12) \_\_\_\_\_. Did you hear about the results of a recent test for three car-teams? The car that followed an Internet website was slowest, the SAT NAV team was second fastest, and arrived eight minutes after the winners, who were using a map!

- 2 Complete the description of the HotCat catamaran with phrases from the box.

a) An important advantage is that b) As a result c) On each side of the  
d) One disadvantage of this design e) The boat performs best when  
f) The design uses g) The result is that h) This design makes i) This means that

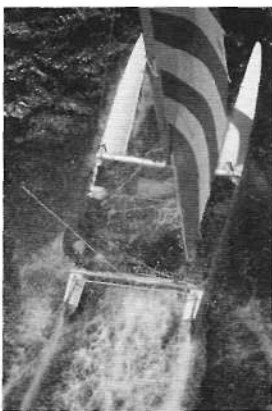

(1) (f) four aluminium alloy beams to connect the twin hulls, and a trampoline fits inside the beams tensioned by a rope. The two-part aluminium and carbon fibre mast is supported at the base by a cup-shaped shoe riveted onto the centre of the forward beam. A downhaul rope tensions the mainsail, and an outhaul rope flattens the bottom edge of the mainsail along the horizontal boom. (2) \_\_\_\_\_, the HotCat is extremely lightweight, which reduces drag and allows for high performance speeds. (3) \_\_\_\_\_ the upwind hull skip across the surface of the water and reduces resistance. (4) \_\_\_\_\_ mast, there are steel wires which support the crew's harnesses. (5) \_\_\_\_\_ the crew can lean out to counterbalance the effect of the wind. (6) \_\_\_\_\_ the HotCat can be pulled up onto the beach. (7) \_\_\_\_\_ sailing at right angles to the wind. It doesn't sail so well into the wind, or with the wind directly behind it. (8) \_\_\_\_\_ is that the bow of the downwind hull may dip into the waves in rough seas and so the boat may turn over. (9) \_\_\_\_\_, in this situation, it is impossible for a single sailor to raise the boat back into an upright position.

## Section 2

- 1 Write the questions for an interview with an engineer about laser drilling.
- 1 (start / investigate) *When did people first start to investigate laser drilling?*  
They first started to investigate laser drilling in 1997.
  - 2 (kind / lasers) \_\_\_\_\_  
They used powerful lasers from a discontinued military programme.
  - 3 (effect / laser beam) \_\_\_\_\_  
It splits the rock, or melts it.
  - 4 (how / split) \_\_\_\_\_  
The laser beam heats up moisture in the rock. The moisture turns to steam which breaks the rock.
  - 5 (split / more efficient / melt) \_\_\_\_\_  
Yes, it's much more efficient than melting it.
  - 6 (energy / require) \_\_\_\_\_  
No, the same amount of energy is used to split different kinds of rocks.
  - 7 (what / research) \_\_\_\_\_  
We're studying multi-beams, using different beams in a single hole.

- 2 Match the applications (1–4) and the descriptions (a–d) to these tools.

- A pulley (4 / \_\_\_\_\_)                      B wheel and axle (\_\_\_\_\_ / a)  
 C rack and pinion (\_\_\_\_\_ / \_\_\_\_\_)    D ratchet and pawl (\_\_\_\_\_ / \_\_\_\_\_)
- 1 car seatbelt    2 car steering    3 dentist's drill    4 lift / elevator

a) Inside the tool, a very small turbine is driven by compressed air at speeds of up to 800,000 rpm. A drill shaft is attached to the turbine at one end and to a drill bit at the other which rotates and cuts into the tooth.

b) A cable is attached to a car at one end and a counterweight at the other end, which balances the weight of the car plus the passengers. At the top of the building, the cable passes over a pulley which is driven by an electric motor.

c) When the steering wheel is turned, it rotates the steering column and the pinion attached at the other end. The pinion moves a rack to the right or left. Each end of the rack moves a track rod connected to one of the wheels.

d) A sudden stop makes the clutch within the belt housing rotate. This moves a pawl which locks the ratchet attached to the belt shaft. The pawl prevents the ratchet from turning, and locks the belt in position.

- 3 Insert one of these phrases where possible in the text. Use each phrase once.

that are    that are    that is    that is    which are    which is    which was    which were

The BOP UW7 is a blowout preventer developed by a team of engineers at Drilling Solutions plc. A blowout preventer (BOP) is a large valve fitted to the top of a well. It is a device designed to prevent oil or gas in the ground from rushing up the drill pipe. By closing this valve, usually operated by remote control, the drilling crew can regain control of the flow of oil or gas.

The BOP UW7 contains several new components invented to improve operations in underwater drilling sites. These include components designed to fit tightly around the underwater drill pipe. Others include cutters fitted with hardened steel shearing surfaces that can cut through the drill pipe in a severe blowout. Drilling Solutions recommends that all BOPs are inspected and tested at regular intervals agreed by the local Safety Officer.



# Audioscript

## Unit 1 Action

02

### Dialogue 1

- A: How do you start this?  
B: First you fill it with fuel and connect this cable here. Then you start the motor by pressing this button.

### Dialogue 2

- A: How does this work?  
B: It's quite simple. First you fix it firmly onto the wall of your house. Probably you need to put it near the front door or the windows. Then you connect it to a power supply inside the house.  
A: So, how does it work?  
B: A person coming near the house turns on the light by activating the motion sensor.

### Dialogue 3

- A: Can you tell me how to use this?  
B: Sure. First you need to charge the battery and insert the card here. Then you switch it on by pressing this button. Then take the photograph.

### Dialogue 4

- A: How does the driver start it?  
B: They sit in the seat and check that the gear lever is in the 'P' position. That means 'Parked'. Then the driver starts the engine by turning the key in the lock there.  
A: And how do they drive off?  
B: The driver presses the brake pedal and moves the gear lever to the 'D' position. That means 'Drive'.

### Dialogue 5

- A: How do you use this?  
B: Easy! Plug the adapter into the wall socket and switch on the electricity supply. Then, plug your mobile into the lead that comes out of the adapter.

### Dialogue 6

- A: So how does this system work?  
B: The store protects high-value goods by attaching a magnetic strip to them. When the goods are sold, the sales person deactivates the strips by passing them over a scanner. A thief will activate the alarm by carrying unsold goods between the transmitter and receiver when he leaves the shop. The still-active tag sets off the alarm.

03

- 1 You start the motor by pressing this button.
- 2 A person coming near the house turns on the light by activating the motion sensor in the light.
- 3 You switch it on by pressing this button.

- 4 The driver starts the engine by turning the key in the lock.
- 5 You have started the charging process by plugging in the adapter and switching it on.
- 6 The store protects goods by attaching a magnetic strip to them.
- 7 The sales person deactivates the strips by passing them over a scanner.
- 8 A thief will activate the alarm by carrying unsold goods between the transmitter and receiver.

## Unit 2 Work

04

[I = Interviewer; L = Laura Verdi]

- I: I've read through your CV.  
L: There are a few changes since I sent it to you. I got married last month so I've changed my surname.  
I: So it's not Laura Muti but ...?  
L: Laura Verdi. That's V-E-R-D-I.  
I: Right, I've got that. And you've applied for the post of Computer Technician.  
L: Yes, but I see from your website that you are also advertising for a Supervisor.  
I: That's correct. Do you want to apply for the post of Supervisor too?  
L: Yes.  
I: Very well. We'll talk about that job in a minute. When exactly did you start your job at Wiggins?  
L: In January 2004. So I've been there four years now.  
I: And you say that you do computer upgrades, such as installing new software, installing memory cards, anti-virus systems and so on.  
L: Yes, but in addition, I now do site visits. I visit some of our bigger clients' offices. I upgrade the computer systems in their offices.  
I: So is that more responsibility and more pay?  
L: Yes, that's right. But they still call me 'Computer Technician'.  
I: And why do you want to leave Wiggins?  
L: It's too far to travel. I'd prefer to work in Swindon, where I'm living now. By the way, Wiggins recently changed its name. It's now called 'SuperLink'. That's S-U-P-E-R-L-I-N-K.

05

- 1 Do you want to apply for that post too?
- 2 When exactly did you start your job at Wiggins?
- 3 So is that more responsibility and more pay?
- 4 Why do you want to leave Wiggins?

06

- 1 1st syllable stressed: engine, mechanism, operator, technical.

- 2 2nd syllable stressed: electrical, electron, mechanical, technician.
- 3 3rd syllable stressed: electrician, electricity, engineer, occupation.

### Unit 3 Comparison

#### 07

- 1 The nearest star that can be seen with the naked eye is called Alpha Centauri. It's 4.36 light years away and can be seen from the southern hemisphere. However, the nearest star to Earth is 4.24 light years away. Its name is Proxima Centauri and it is so faint that you cannot see it with the naked eye.
- 2 The deepest part in the world's oceans is in the Pacific Ocean, at a place called the Marianas Trench. A Japanese ship sent down an unmanned probe to the bottom of the ocean there, to a depth of 10,911 metres.
- 3 The Mohs scale of mineral hardness was created in 1812. It ranges from talc, which is number one on the scale, to diamond which is number ten. Silver is between 2.5 and 3. Iron is between four and five. Glass is between six and seven. So silver is the softest of the three materials and glass is the hardest.
- 4 The most common of these three gases in the atmosphere is nitrogen. After that comes oxygen. Hydrogen is less common than oxygen and is the least common of these three gases.
- 5 So far the hottest temperature recorded on Earth was at a place called Al Azizyan in Libya. The temperature reached a record 58° Celsius.
- 6 The coldest temperature ever recorded on Earth was in 1983. A temperature of -89° Celsius was recorded at a place called Vostok in Antarctica.

#### 08

- 1 The nearest star *that can be seen with the naked eye* is called Alpha Centauri. It's *4.36 light years away* and can be seen from the southern hemisphere.
- 2 A *Japanese* ship sent down an *unmanned* probe to *the deepest point* on the seabed at a place called the Marianas Trench in the *Pacific Ocean*.
- 3 The Mohs scale of mineral hardness was *created in 1812*. It ranges from talc, which is *number one* on the scale, to diamond, which is *number ten*. Silver is *the softest* of the three materials and glass is *the hardest*.
- 4 *The most common* of these three gases in the atmosphere is *nitrogen*. Hydrogen is *less common than oxygen* and is *the least common* of these three gases.

### Unit 4 Processes

#### 09

[I = Interviewer; D = Director]

An interviewer talks to the Communications Director of the High-Speed Rail Link project.

- I: You must be very pleased with the successful completion of the project.
- D: You're right. The French built their high-speed link 13 years ago and now we've just finished ours.

- I: It's November 2007 and I've just made the journey from Paris to London. It took me only two hours and fifteen minutes. How fast do the trains go?
- D: Eurostar trains can now travel at a speed of up to 298 kph.
- I: That's faster than it used to be.
- D: Yes, when the Channel Tunnel opened in 1994, trains on the English side had to use the existing rail link from Folkestone to Waterloo. The journey time then between London and Paris was two hours and fifty-five minutes. Things speeded up a bit in 2003, when Stage 1 of the High-Speed Link opened.
- I: So how long has Stage 2 of the project taken?
- D: It's taken over 11 years. Engineers have worked for more than 100 million hours, building over 60 kilometres of tunnels. The twin-bore tunnels – that's two tunnels running side by side – pass under seven miles of surface railway track.
- I: And you used a tunnel drill like the one in this photo.
- D: In fact we used seven of them. The ground under London and the southeast was so hard that we wore out six of them.
- I: That must have been expensive.
- D: Yes, at a cost of £10 million each, that means we spent £70 million on tunnel drills.
- I: I think I now understand the size of the project.
- D: Good! Between Folkestone and London your train has just travelled through 32 kilometres of tunnel and crossed over 150 bridges.
- I: Thanks for all that information.

#### 10

- 1 You must be very pleased with the successful completion of the project.
- 2 The French built their high-speed link 13 years ago and now we've just finished ours.
- 3 Eurostar trains can now travel at a speed of up to 298 kph.
- 4 The twin-bore tunnels pass under seven miles of surface railway track.
- 5 Did you use a tunnel drill like the one in this photo?
- 6 The ground under London was so hard that we wore out six of them.
- 7 It means we spent £70 million on drills.

### Unit 5 Descriptions

#### 11

- 1 The front of the building is made up of two very large wedges, which is unusual. In the centre, between the two wedges, there is a large open space, which is triangular. The windows in the building are all square or rectangular. From the front of the building there are good views over the river.
- 2 The windows in this building are all square or rectangular. At the bottom of the building are pointed arches for the entrances to the building. There is a single large balcony at the front, on the first floor. Higher up, the front of the building divides into three triangular parts, with the sides

of the triangles rising in steps. There is a small pointed dome at the top in the centre, supported by eight thin columns.

- 3 This is a rectangular town house, which fits between two others. All the windows are rectangular, and they all have balconies. Some of the balconies are rectangular with rounded corners. The others are triangular with rounded corners.
- 4 Some of the windows in this building are rectangular. Others are in the shape of rounded or pointed arches. Steps lead up to the main entrance, which is in the form of three arches. The top part of the clock tower is very thin and reaches high into the sky.

#### 12

[I = Interviewer; E = Expert]

#### Picture D

- I: Where is this building exactly?  
E: It's in Copenhagen, in Denmark. It was completed in 1999.  
I: And what is it exactly?  
E: It's a library. It's the Royal Danish Library.  
I: And the name of the architect?  
E: The company that designed the building is Schmidt, Hammer and Lassen.  
I: Schmidt, Hammer and ...?  
E: Lassen. I'll spell the names for you. S-C-H-M-H-I-D-T, H-A-M-M-E-R, and L-A-S-S-E-N.

#### Picture C

- I: What about this building?  
E: It's a town house in Barcelona, in Spain. It was completed between 1898 and 1899.  
I: And why is this house famous?  
E: The architect was Antoni Gaudi.  
I: Could you spell that name please?  
E: Yes. A-N-T-O-N-I, G-A-U-D-I.

#### Picture A

- E: This building is a hospital in Barcelona. Or rather, part of a large hospital called Sant Pau. That's S-A-N-T, P-A-U.  
I: Thanks. Is the architect famous too?  
E: Oh yes. It was designed by the architect Montaner. That's M-O-N-T-A-N-E-R. It was completed in 1930.  
I: Thank you very much.

#### 13

Two-dimensional adjectives: triangular, rectangular, semi-circular, circular, square.

Three-dimensional adjectives: conical, cylindrical, dome-shaped, hemispherical, cubic, spherical.

#### Unit 6 Procedures

#### 14

- 1 Go straight ahead at the crossroads.
- 2 Turn left at the second set of traffic lights.
- 3 At the roundabout, take the third exit.
- 4 At the roundabout, go down the slip road and join the motorway.
- 5 Come out of the station car park and turn left.

- 6 Take the second turning on the right.
- 7 You'll pass a garage on your left.
- 8 Turn right at the T-junction.

#### 15

#### Directions 1

Remember, you'll be driving on the left. On the motorway, you'll see a slip road for Swindon Business Park. Don't take that one. Go on about two kilometres further and take the second slip road. That one is also marked Swindon Business Park. Follow the slip road. It'll go through an underpass under the motorway. Now, there are two sets of traffic lights along this road. Turn right at the second set... yes, the second set. Go straight ahead at the roundabout. Then you'll see some shops on your right. Opposite the shops, you'll see our office on the left. Turn left and drive round to the Visitors' Car Park at the back.

#### Directions 2

Go along the motorway. Take the first slip road on your left. It'll be marked Swindon Business Park. Follow the slip road down a short hill and you'll come to a T-junction. Turn right here, yes right ... and go under the bridge. This is an underpass under the motorway. Go a little further. At the first crossroads, go straight ahead. Then you'll see a park on your right. At the second crossroads, turn left. You'll see our office on the corner on the left. Drive into the Visitors' Car Park at the front.

#### Unit 7 Services

#### 16

[P = Peter; C = Customer]

- P: Good morning, Customer Service. My name's Peter. How can I help you?  
C: Yes, good morning. I'm ringing up to complain about a DVD player I bought online from you.  
P: Oh, I'm sorry to hear that. What's the problem?  
C: It just doesn't work. It's never worked since I took it out of the box.  
P: Does the LED come on when you switch it on?  
C: Yes.  
P: And can you put a DVD in?  
C: Yes.  
P: And when you press 'Play', what happens?  
C: The disk goes round, but the screen is blank.  
P: Well, I do apologise for that. There must be something wrong with the machine. What model is the DVD player?  
C: It's ... let me see. It's a 2086 model.  
P: And could I have your name please?  
C: Yes, my name is Antonia Rostock. That's R-O-S-T-O-C-K.  
P: And do you have the order number at hand?  
C: Yes, it's order number 386502/08.  
P: Good, I've got that. Right, Ms Rostock, can I just summarise the problem? You've told me that the DVD player that you bought online from us doesn't work and has never worked. Is that right?

- C: Yes, that's right.  
 P: Well, I can tell you that we'll replace your DVD player. You'll receive a replacement by courier by the end of next week. Are you still at the same address, in Liverpool?  
 C: Yes.  
 P: Good. We'll collect the faulty player from you at the same time.  
 C: That's great news.  
 P: And we'll give you a £5 discount off your next purchase.  
 C: Good! I'll accept that. Thank you.

 17

[CS = Customer Service; C = Customer]

**Dialogue 1**

- CS: Can I help you?  
 C: Yes, you can. Look at my case! The surface is burnt. Look at that burn mark! And the lock is jammed.

**Dialogue 2**

- CS: How can I help you?  
 C: My case got damaged during the flight.  
 CS: I'm sorry to hear that. Could you show me?  
 C: That's not difficult! Look, the handle is all crushed and twisted. And the top is dented, see – there! And it's scratched.

**Dialogue 3**

- CS: How can I help you?  
 C: You've just delivered a desk to our showroom. At SRN Office Stores. The problem is, it's badly damaged. The top surface is very badly scratched. And the front right-hand leg is bent.

**Dialogue 4**

- CS: Can I help you?  
 C: I've got a complaint. You've just delivered a desk to our office. It's damaged. The bottom drawer is jammed and it's dented.  
 CS: Dented?  
 C: Yes. As you look at the front of the desk, it's dented on the left-hand edge.

**Dialogue 5**

- CS: This is EasyHire. We've got a problem with the hire car which you returned last night.  
 C: Oh really?  
 CS: Yes. The windscreen is cracked at the bottom corner, on the passenger's side. And the driver's door is jammed. We can't open it.

**Dialogue 6**

- CS: Hello. This is EasyHire. We've got a problem with the hire car which you returned this morning.  
 C: Oh, I'm sorry to hear that. What's the problem?  
 CS: One of the front sidelights is broken. And the driver's door is badly dented. We'll have to replace the door.

**Unit 8 Energy**

 18

- A. The motion of a rocket is linear. Jet engines force the rocket in a single forwards direction.

- B. Oscillating motion is found in machines like clocks and watches. The pendulum of a clock oscillates from side to side. As it swings, it rocks the anchor, which advances the escape wheel by one tooth at a time. So the escape wheel rotates in short steps, and controls the driving wheel and the hands of the clock.  
 C. The pistons of diesel and petrol engines move in a reciprocating motion. They move upwards and downwards in the cylinders. The pistons of a steam engine also reciprocate, but move horizontally. The blades of many cutting machines have a reciprocating action, for example, a hand-held saw.  
 D. Electric motors provide rotary power to lots of machines, tools and devices. The hard-disk drive in a computer rotates. Other examples with rotary motion include fans, outboard motors and circular saws. A chain saw has a band of steel teeth, which is driven round and round by the motor.

 19

- 1 Our range of pumps operates at pressures from 70 to 2,750 bar.
- 2 Pumps can operate to a maximum flow rate of 773 litres per minute.
- 3 Diesel units are available as site trailers or road trailers.
- 4 Standard electric units can be mounted on skids or trailers.
- 5 Our accessory range includes hoses, nozzles, guns and foot valves.
- 6 These allow the operator to shut off the water jet with their foot.
- 7 Hoses range from 6–32 mm in diameter, to suit all applications.

 20

Now I'm going to talk about some applications of water jetting in three industries. I'm going to give you a few examples; of course, there are many more.

Let's look at this first slide, the automotive industry, so we're talking about the manufacture of cars, lorries, buses and so on.

As one example, we can use water jetting to remove paint from machinery and conveyors. Because it's hard to remove paint, we may use pressures from 10,000 psi up to 40,000 psi. Yes, that's forty thousand, four-oh.

Let's look at a second industry, the construction industry, so the construction of buildings, roads, bridges and so on. In this industry, we can use water jetting for removing concrete, or dirt, or oil from all kinds of vehicles and mixer trucks. We don't need a high pressure for this; 5,000 psi will be high enough. A third industry is highway maintenance, so the maintenance of roads, bridges and so on. Two applications here: the first is the removing of oil and mud from roads, bridges and flyovers. For this we use a pressure of between 5,000 and 10,000 psi. The second application is for clearing blockages from drains. For this we need a higher pressure, say between 10,000 and 14,500 psi.

Do you have any questions about these sample applications?

### Unit 9 Measurement

[I = Interviewer; T = Technician]

#### 21

- 1 I: How safe were the cars that were tested in 1997?  
T: Compared with today, they were much less safe.
- 2 I: What safety features did they have in 1997?  
T: They had very few. Almost none of the cars had airbags.
- 3 I: What do you mean by a 'marginal' safety rating?  
T: 'Marginal' means 'not very satisfactory', or in other words, 'not very good'.
- 4 I: Is one-star better or worse than five-star?  
T: One-star is the lowest safety rating. Five-star is the highest safety rating today.
- 5 I: Are cars safer now than they used to be?  
T: New cars are safer now, because they are stronger and have more safety features.

#### 22

- I: How safe were the cars that you tested in 1997?  
T: Compared with today, they were much less safe. They had very few safety features. For example, almost half of the cars didn't have airbags. Out of these four small cars, one of them didn't have an airbag.
- I: Which one was that?  
T: The Lindos had no airbag.
- I: What about the other three?  
T: Well, the Hydra and the Syros both had a single airbag for the driver. And the Paxos had dual airbags, so better than average.
- I: And did it have the highest safety rating?  
T: No, in fact it didn't. The Paxos was rated 'acceptable'. The Syros was rated 'good'. The Hydra was rated 'marginal' and the Lindos was rated 'poor.'

#### 23

- I: Tell me about the results for 2000.  
T: As you can see, they were still selling a few cars without airbags. So the Lorca, for example, had no airbag.
- I: And what about the other three?  
T: The Pamplona and the Malaga both had dual airbags. The Zamora just had one driver's airbag.
- I: What about their safety ratings? Were they better than in 1997?  
T: Yes, generally. As you can see, we changed to a star rating, with one-star the lowest and four-star the highest safety rating.
- I: And did any of these four cars get a four-star rating?  
T: Yes, the Malaga had a four-star rating and the Pamplona had three stars. The Zamora had two stars and the Lorca had a one-star rating.

#### 24

- I: Tell me about the results for 2007.  
T: Well, by 2007 a five-star rating had become the highest rating because safety standards had

improved so much. All but two of the cars that we tested got a five-star rating. The two models that didn't get five stars had a four-star rating. And all the cars had airbags.

- I: All of them?  
T: Yes, all eight of them. One of the cars had only one airbag for the driver.
- I: I see. And the other seven?  
T: They all had front, side and head airbags.

### Unit 10 Forces

#### 25

- 1 break a ble
- 2 in au di ble
- 3 por ta ble
- 4 re sis tant
- 5 e las tic
- 6 un mo vea ble
- 7 un bend a ble
- 8 wa ter proof
- 9 com bus ti ble
- 10 cor ro sion

#### 26

- 1 The digital camera fits easily into your hand and weighs only 125 grams. It withstands corrosion and should last for years.
- 2 The diver's watch is for specialist divers and is waterproof up to 60 metres. It's also very tough and won't break. Corrosion? Not a problem. Just rinse the watch after diving in salt water.
- 3 If you want to keep your documents and valuables safe at home, why not get a home safe from our range? Each model is very strong and very heavy, so burglars won't be able to carry it out of your house. It also protects the contents from fire and heat and resists corrosion.
- 4 We sell a large range of helmets for cyclists and bikers. Our bikers' helmets are very strong. They don't burn, they don't break and they withstand corrosion.

#### 27

The main aim of this presentation is to discuss the danger to London of flooding, and to examine the causes. We'll also examine the topic of flood defences. I'd like to start by listing three main causes of possible flooding: (1) the rise in sea levels; (2) the combination of high tides and surge tides coming from the north-east; (3) the sinking of southeast England.

Let's move on to flood defences. In the 1970s, the banks of the River Thames below London were raised by two metres. About 32 kilometres of flood defences were improved in this way. Above London, approximately 80 kilometres of river banks were raised.

That brings me to the Thames Barrier, a huge moveable flood barrier that was built in the 1970s. As you can see in this photo, the barrier consists of ten moveable gates, which are pivoted and supported between these concrete piers. When closed, the barrier

can withstand a pressure of 9,000 tonnes. The problem, however, is that this barrier will not be enough to prevent future flooding, because sea levels are rising. As shown on the first graph, in 2001 an IPCC report predicted an annual rise of less than 2 mm. This forecast a rise of just over 40 cm in sea levels by the end of the twenty-first century.

However, the next graph indicates that sea levels are rising faster than we expected. Between 1993 and 2006, sea levels rose by 3.3 mm per year on average. This would result in a rise of nearly 90 cm by the end of the century.

My objective in this talk has been to list the factors that could cause flooding, to examine the possible effects, and to discuss methods of flood prevention. I'd like to finish by showing you this map of the areas of London that will be below sea level by the year 2100. If we do nothing, all these areas will flood.

### Unit 11 Design



Good morning everyone.

The aim of this talk is to examine the difference between monohull ferries and multi-hull ferries, or catamarans. I'd like to start by asking you a question. How old is the catamaran design? The answer is that it was probably first used by fishermen in southern India about 1,500 years ago. Later the design spread through southeast Asia.

And that brings me to the design of the catamaran. It has two hulls, which are joined together by a frame. In the West, people have built sporting and commercial catamarans for the past 100 years. And now they are also used as very large ferries, like the one on this slide. Each of the two hulls is powered by one engine.

All right, now let's turn to some of the advantages of the catamaran design. First, they're lighter and faster. Also, because multi-hulls are wider than monohulls, their stability is better. The catamaran goes fastest when the waves are small. Now I'd like to move on to the dimensions of these ferries. If you look at this next slide, you can see the largest catamaran ferry in use today. It's approximately 126 metres long, just over 40 metres wide, and has a depth of 4.8 metres in the water.

Right, so now let's look at the load that this ferry can carry.

First, the HSS 1500. It can carry over 1500 passengers and 375 cars. Next, the HSS 900. As its name suggests, it can carry 900 passengers and just over 200 cars.

Let's talk about performance data. How fast can it go? When in service, the HSS 1500 travels at over 75 kph, although it can reach a maximum speed of over 110 kph. The HSS 900 is a little slower.

So, was there a problem with the catamaran design?

No. But there was a problem with the aluminium alloy used for the hulls.

Finally, I should mention some more disadvantages of the multi-hull ferry. An important one was the build

cost. It is always more expensive to build a multi-hull ferry than a monohull ferry. Then there was the question of running costs.

I'd like to finish by showing you this graph, which compares the fuel costs of the two types of ferry, monohull and multi-hull. There's a huge difference! It's more expensive to run one multi-hull ferry than it is to run seven monohull ferries.

So, the most important factor today is fuel consumption. Fuel costs are certain to rise, not fall, in future. So, I don't think we shall see the construction of any more multi-hull ferries.

Thank you.

### Unit 12 Innovation



I: Hello and welcome. This week, we have an expert on car and lorry sensors, Hans Anklam. Welcome, Hans. So let's talk about the new tyre sensor which your company has developed. First of all, what is it exactly?

SE: It's a Tyre Pressure Monitoring System, or TPMS for short.

I: And what's it for? What does it do exactly?

SE: It monitors the pressure and temperature of your tyres.

I: Why do we need this new sensor?

SE: The first reason is to prevent road traffic accidents. 20 percent of accidents are caused by tyre failure. In addition, a survey showed that 20 percent of cars had tyres that were under-inflated.

I: So, using these sensors will help reduce accidents?

SE: Yes, definitely.

I: And what technology or principle is this sensor based on?

SE: It makes use of electronic sensor technology, and also wireless data display.

I: So the main component is a sensor?

SE: That's right. It's placed directly onto the wheel inside the tyre, with a clamp-in or snap-in fitting.

I: So, tell me about its operation. How does it work?

SE: The system consists of four valve-mounted tyre pressure sensors, and one central radio frequency receiving unit, which is powered by batteries. The information is transmitted by wireless to the display in front of you, where you can see the pressure and temperature data.

I: And it's easy to install, you say?

SE: Yes, because there are no wires. And the battery lasts for ten years, or 100,000 miles.

Right! Could you sum up the advantages of this new tyre pressure monitoring system?

SE: Of course. Number one, it reduces tyre failure and resulting accidents. Two, it helps reduce tyre wear. And three, it helps to reduce fuel consumption.

I: Really?

SE: It's a fact. And we all know how much a tankful of petrol costs these days.

# Answer key

## 1 Action

### 1 Teamwork

- 1 1 socket 2 nozzle 3 flap  
4 mechanic 5 wheelgun 6 hose  
7 crew 8 jack

Vertical word: teamwork

- 2 1 Drive the fuel tanker to the plane.  
2 Open the fuel flap under the wing.  
3 Push the nozzle into the fuel socket.  
4 Switch on the pump.  
5 Pump fuel into the plane's fuel tanks.  
6 Switch off the pump.  
7 Remove the fuel nozzle.  
8 Close the fuel flap.  
9 Clean any spilled fuel off the plane.

- 3 1 The car leaves the pit lane.  
2 The driver closes the fuel flap.  
3 They tighten the wheel nuts.  
4 They lower the car to the ground.  
5 Someone switches off the fuel pump.  
6 They put on the new wheels.  
7 They bring out the new wheels.

### 2 Training

- 1 B: I've switched it on.  
B: I'm lifting it up now.  
B: I've taken them out.  
B: I'm putting them in now.  
B: I've pushed them in.  
B: I've pressed 'Return'.  
B: I'm waiting. I'm still waiting! Ah! I think it's finished.  
A: Good! Now you can turn/switch off the printer, or print a document.
- 2 1 S: How are you getting on?  
T: Just a minute. I've taken apart the alarm.  
S: Good. Have you checked the wiring?  
T: No, not yet. I'm still checking it.
- 2 S: How is the work going?  
T: Hang on. I'm still cleaning the spark plugs.  
S: Have you put on the new tyres yet?  
T: Yes, I've put them on.
- 3 S: How are you getting on?  
T: Just a minute. I've taken off the handles.  
S: Have you painted the doors yet?  
T: No, I'm still painting them. It's almost finished.
- 4 S: How is the work going?  
T: I'm still fitting the new hard disk. It's almost finished.  
S: Have you installed the memory card yet?  
T: No, not yet. I'll do it next.

## 3 Method

- 1 A5 B4 C3 D2 E6 F1

- 2 1 You start the motor by pressing this button.  
2 A person coming near the house turns on the light by activating the motion sensor.  
3 You switch it on by pressing this button.  
4 The driver starts the engine by turning the key in the lock.  
5 You start the charging process by plugging in the adapter and switching it on.  
6 The store protects goods by attaching a magnetic strip to them.  
7 The sales person deactivates the strips by passing them over a scanner.  
8 A thief will activate the alarm by carrying unsold goods between the transmitter and receiver.

- 3 1 How much does the robot weigh?  
2 How tall is the robot?  
3 How does the robot stay upright on the bike?  
4 What helps the robot ride in a straight line?  
5 Where is the camera?  
6 How does the robot follow the correct road?  
7 How does the robot receive instructions?  
8 Where is the wireless receiver?

## 4 Word list

- 1 wheel-gun 2 front/rear 3 air pressure  
4 outboard motor 5 emergency stop  
6 accelerator 7 visor 8 water heater  
9 chest

## 2 Work

### 1 Routines

- 1 a) second picture b) first picture c) third picture
- 2 1 What is Sven doing today?  
2 He trains sub-sea engineers.  
3 He's operating the main crane.  
4 He maintains the pumps.  
5 He's conducting a fire drill.  
6 What does Eric usually do?
- 3 1 The Electrician  
2 The Maintenance Supervisor  
3 The Derrick Man  
4 The Crane Operator  
5 The Derrick Man  
6 The Driller  
7 The Assistant Crane Operator and the Roustabout

## 2 Plans

- 1
  - 1 is going out
  - 2 are they going to do?
  - 3 are going to inspect
  - 4 is going?
  - 5 are they going to stay
  - 6 want to finish
  - 7 need to inspect
  - 8 intend to come
  - 9 hope to start

2 steel mesh barriers, lightweight safety nets

3 Dear Peter,  
Thanks for your email.  
With reference to your enquiry about steel mesh barriers, I confirm that I have found a company that supplies a good product. I attach some pages from their website. Do let me know if you think this system is suitable.  
The same company also supplies and fits safety nets. As you are aware, it is important to fit the safety nets correctly.  
Could you please let me know if you need prices before Friday?  
Regards,  
Jay

## 3 New job

1 1

Curriculum Vitae	
<b>Personal information</b>	
Surname / First name(s)	Verdi, Laura
Desired employment	(1) Computer technician (2) Supervisor
<b>Work experience</b>	
Dates	From January 2004 to 2008
Occupation or position held	Computer technician
Main activities and responsibilities	Do computer upgrades; install software, memory cards, anti-virus systems, etc. Do site visits. Upgrade clients' computer systems.
Name and address of employer	SuperLink, Unit 12, Delly End Industrial Estate
Type of business or sector	Information Technology
Reason for leaving present/last employer	wants to move to Swindon; it's too far to travel to present company; now living in Swindon.

- 2
  - 1 Do you want to apply for that post too?
  - 2 When exactly did you start your job at Wiggins?
  - 3 So is that more responsibility and more pay?
  - 4 Why do you want to leave Wiggins?
- 3
  - 1 1st syllable stressed: engine, mechanism, operator, technical.
  - 2 2nd syllable stressed: electrical, electron, mechanical, technician.
  - 3 3rd syllable stressed: electrician, electricity, engineer, occupation.

## 4 Word list

- |                   |                 |
|-------------------|-----------------|
| 1 Crane operators | 2 Electricians  |
| 3 Drillers        | 4 Engineers     |
| 5 Safety Officers | 6 Site Managers |
| 7 Roustabouts     |                 |

# Review Unit A

## Section 1

- 1
  - 1 He's replacing the spark plugs. B
  - 2 They're carrying some batteries. K
  - 3 She's rotating the wheel. I
  - 4 They're examining the generator. C
  - 5 She's stripping off the old paint. E
  - 6 He's activating the alarm. J
  - 7 She's inserting a key. L
  - 8 She's running a training course. F
  - 9 He's raising the car. A
  - 10 She's stepping on the alarm pad. G
  - 11 He's putting on a fire suit. D
  - 12 She's receiving a mobile signal. H
- 2
 

bring out – take away	loosen – tighten
lower – raise	put in – take out
put on – take off	start – turn off
switch off – switch on	
- 3
 

1 turn off	2 raise	3 take off
4 loosen	5 take out	6 put in
7 tighten	8 put on	9 lower
10 switch on	11 start	

## Section 2

- 1
 

1 position	2 CV
3 personal information	4 education
5 qualifications	6 training
7 business sector	8 skills
9 work experience	10 job title
11 job description	12 interview
13 employer	14 activities
15 responsibilities	
- 2 Thanks for your email. With regard to the Safety Conference next week, I'd like to confirm that I plan to attend. Sorry for the short notice. I attach the PowerPoint slides that you requested. This is also to let you know that I'll email you the Executive Summary by Friday at the latest. As you may know, Marco Burgos has been ill for the past month. I am sorry to tell you that he is



going into hospital for an operation. Fortunately, his deputy, Pedro Granada, will take part in the Forum instead. I would appreciate it if you could forward this email to the person responsible for printing the Conference Programme. Do let me know if you need any further information. Kind regards, Kurt Brandt.

### 3 Comparison

#### 1 Limits

- 1 1 35 minutes.  
 2 A crossing by tunnel.  
 3 Containers, unaccompanied trailers, large abnormal loads.  
 4 Journeys are quicker; loading and unloading takes less time; there are more frequent train journeys than ferry departures; the trains are not affected by the weather.  
 5 Bad weather can cause delays or cancellation of ferry departures.
- 2 1 Lorries *must not be heavier* than 44 tonnes.  
 2 Lorries *must not be longer* than 18.75 metres.  
 3 Lorries *must not be higher* than 4.2 metres.  
 4 Lorries *must not be wider* than 2.6 metres.  
 5 The *length limit* depends on the individual ferry.  
 6 The *height limit* for lorries on all ferries is 4.8 metres.  
 7 The *width limit* for lorries on all ferries is 6.7 metres.  
 8 The *weight limit* for standard lorries is 44 tonnes.

#### 2 Products

- 1 1f 2c 3a 4g 5d 6b 7e

##### 2 Sample answer

- 1 Would you like me to put you through to our Sales Department  
 2 shall I send you a catalogue?  
 3 Could you give me your name and address, please?  
 4 Is that B for Bravo or P for Peter?  
 5 And your address, please?  
 6 Could you spell 'Wyatt', please?  
 7 Would you mind repeating the post code?  
 8 Could I take a phone number?

##### 3 Sample answer

- 1 Which one would you like to order, the 150 or the 200?  
 2 The larger one, the 200 model.  
 3 I'd like the larger one, please.  
 4 I'd like the red and cream one.  
 5 Right, I'll take the more expensive one, the one at €525.

### 3 Equipment

- 1 1b 2c 3b 4b 5c 6b

- 2 1 The nearest star that can be seen with the naked eye is called Alpha Centauri. It's 4.36 light years away and can be seen from the southern hemisphere.  
 2 A Japanese ship sent down an unmanned probe to the deepest point on the seabed at a place called the Marianas Trench in the Pacific Ocean.  
 3 The Mohs scale of mineral hardness was created in 1812. It ranges from talc, which is number one on the scale, to diamond, which is number ten. Silver is the softest of the three materials and glass is the hardest.  
 4 The most common of these three gases is nitrogen. Hydrogen is less common than oxygen and is the least common of these three gases.
- 3 1 Sherakhan is the least expensive of the yachts.  
 2 Oceanco 702 is not as expensive as Alysia.  
 3 The second longest yacht is O'Mega.  
 4 Alysia is the second fastest of the yachts.  
 5 Fewer guests can stay on O'Mega than on Alysia.  
 6 There are fewer crew members per guest on Alysia than on Oceanco 702.

#### 4 Word list

- 1 trailer 2 luggage 3 cubic capacity  
 4 roof rack 5 4x4 6 steel rim wheel  
 7 wheelbase 8 clearance 9 cab

### 4 Processes

#### 1 Infrastructure

- 1 Channel tunnel opens: 1994  
 Rail Link Stage 1 opens: 2003  
 Rail Link Stage 2 opens: 2007  
 London-Paris (2002): 2 hours, 55 minutes  
 London-Paris (2007): 2 hours, 15 minutes  
 Stage 2 took 11 years  
 Manpower: 100 million hours  
 Number of tunnel drills used: 7  
 £70 million @ cost per drill: £10 million  
 A train travels through 32 kms of tunnels and over 150 bridges
- 2 1 You must be very pleased with the successful completion of the project.  
 2 The French built their high-speed link 13 years ago and now we've just finished ours.  
 3 Eurostar trains can now travel at a speed of up to 298 kph.  
 4 The twin-bore tunnels pass under seven miles of surface railway track.  
 5 Did you use a tunnel drill like the one in this photo?  
 6 The ground under London was so hard that we wore out six of them.  
 7 It means we spent £70 million on drills.

- 3** Antifreeze is used to prevent the water in the radiator from freezing.  
Rust is prevented from building up in the radiator system by the use of antifreeze.  
Also, the boiling point of the water in the cooling system is increased.  
First the bonnet of the car is opened.  
Then the cap to the reservoir is unscrewed.  
Next the antifreeze is poured into the reservoir.  
At this stage, a funnel is used to avoid spilling antifreeze onto the car.  
Finally, after pouring in the correct amount, the cap is screwed back on.

## 2 Manufacturing

- 1** 1E 2A 3C 4D 5F 6B
- 2**
- 1 First, all the ingredients are weighed and mixed together in large tubs. Cream, milk and sugar are used to make ice cream.
  - 2 First, the mix is heated to 82° C to kill off bacteria. Then the mix is cooled rapidly to 4° C.
  - 3 Next, flavours and colours are added to the mix.
  - 4 Then the mix is pumped through a special barrel freezer. Simultaneously, a lot of air is whipped into it. Up to half the volume of ice cream is air.
  - 5 At this point, fruits, nuts or biscuit pieces are added to the semi-frozen mixture.
  - 6 Finally, the ice cream is packed in tubs and put into a blast freezer at -30° to -40° C. So the tubs of ice cream are frozen to make them harder.

## 3 Communications

- 1**
- |                                  |                 |
|----------------------------------|-----------------|
| 1 antennas                       | 2 downlink      |
| 3 uplink                         | 4 radio         |
| 5 computer                       | 6 puffer jets   |
| 7 pressurised tank               |                 |
| 8 ring of rechargeable batteries |                 |
| 9 solar panels                   | 10 bus (=frame) |
| 11 main rocket nozzle            |                 |
- 2** 1b 2a 3a 4b 5a 6b 7a
- 3**
- 1 The first artificial satellite was a metal ball, which measured 1 metre across and weighed 83 kg.
  - 2 It had four long antennas, which sent radio signals back to Earth.
  - 3 The first creature in space was a dog called Laika, which spent ten days in orbit in 1957.
  - 4 In 1968, Apollo 8, which orbited the Moon, sent photos back to Earth.
  - 5 The first man on the Moon was Neil Armstrong, who landed there in 1969.
  - 6 The first tourist in space was a man called Mark Shuttleworth, who paid \$20 million for his trip.
  - 7 Two Mars Rovers, which landed in 2003, sent back information about the planet to Earth.

## 4 Word list

- 1** conveyor belt, drive shaft, hydraulic cylinder, drain plug, assembly line, air conditioning, filler cap, laser guide, paint shop, PC monitor, satellite dish, feed horn, communications satellite, DTV card

- 2** At the beginning: first  
After this: next, then  
At the same time: meanwhile, simultaneously  
At the end: finally, lastly

# Review Unit B

## Section 1

- 1**
- 1 faster
  - 2 more
  - 3 higher
  - 4 more often
  - 5 larger
  - 6 larger
  - 7 more
  - 8 greater
  - 9 safer
  - 10 faster
  - 11 more powerful
  - 12 better
  - 13 more expensive
  - 14 over
  - 15 less
  - 16 better
- 2**
- 1 Letter: If your item fits inside the blue area, i.e. is less than 240 × 165 mm, is no thicker than 5 mm and weighs under 100g, it is classed as a Letter.
  - 2 Large Letter: If your item fits inside the grey area, i.e. is less than 353 × 250 mm, is no thicker than 25 mm and weighs under 750g, it is classed as a Large Letter.
  - 3 Packet: If your item fits inside the white area, i.e. is more than 353 × 250 mm or is thicker than 25 mm or weighs over 750g, it is classed as a Packet.

## Section 2

- 1**
- |                   |                |
|-------------------|----------------|
| 1 which weigh     | 13 are fed     |
| 2 are transported | 14 which       |
| 3 are loaded      | 15 are waxed   |
| 4 which is        | 16 to          |
| 5 is pressed      | 17 First       |
| 6 which           | 18 is made     |
| 7 by              | 19 is fitted   |
| 8 Next            | 20 are fed     |
| 9 is glued        | 21 are         |
| 10 is trimmed     | 22 Finally     |
| 11 cut            | 23 are banded  |
| 12 After this     | 24 transported |
- 2**
- 1 Satellites are put into orbit round the Earth by rockets.
  - 2 Electricity is provided by cells on the solar panels.
  - 3 A satellite's orbit is changed by the rocket at the base of the satellite.
  - 4 Weather pictures all over the world are collected by dozens of satellites in orbit.
  - 5 Weather photos are transmitted back to Earth by radio signals.
  - 6 Images from survey satellites are used by computers to update maps.

## 5 Descriptions

### 1 Uses

- 1 1 Chisels are for cutting out pieces of wood.
  - 2 *Jump leads* are used for carrying an electrical current from a charged battery to a flat one.
  - 3 Carburettors are designed to mix fuel with air.
  - 4 The two thick fins at the rear of a ship act as stabilisers.
  - 5 Lightning conductors are designed to carry electricity down the side of a building in a thunderstorm.
  - 6 The impeller on a jet ski acts as a propeller and pushes the craft through the water.
- 2 A: 3, 4, 9, 10, 12    B: 1, 6, 8    C: 2, 5, 7, 11
- 3 1 Several of them tied together can function as a rope.
  - 2 You can split it and sow seeds in it.
  - 3 You can cover a container of rubbish with it.
  - 4 Several of them can act as protectors on the sides of a boat.
  - 5 You can put one over your bed to keep out insects.
  - 6 It can be used for covering furniture.

### 2 Appearance

- 1 1D 2B 3C 4A

	Building A	Building C	Building D
City	Barcelona	Barcelona	Copenhagen
Country	Spain	Spain	Denmark
Type of building	hospital	town house	library
Year	1930	1898-1899	1999
Architect	Montaner	Antoni Gaudi	Schmidt, Hammer & Lassen

- 3 1 triangular    2 conical    3 rectangular  
4 cylindrical    5 semi-circular    6 dome-shaped  
7 hemispherical    8 circular    9 square  
10 cubic    11 spherical
- 4 Two-dimensional adjectives: triangular, rectangular, semi-circular, circular, square.  
Three-dimensional adjectives: conical, cylindrical, dome-shaped, hemispherical, cubic, spherical.

### 3 Definitions

- 1 1E 2B 3C 4A 5F 6D

- 2 1 The Ultrasonic Distance Meter is a portable instrument that/which allows you to measure large rooms.

- 2 The Zoomba Vacuum Cleaner is a rechargeable robot that/which cleans floors automatically.
  - 3 The Garage Parking Sensor is a sensor system that/which fits to your garage wall and helps you to park safely.
  - 4 The Ticko mini helicopter is a radio-controlled toy that/which flies for up to 10 minutes.
  - 5 Street Gliders are two-wheeled devices that/which fit on the heels of your shoes.
  - 6 The Extendable Window Cleaner is a tool that/which extends up to 3.5 metres and allows you to clean high windows from the ground.
- 3 1 A sales person is a person who takes an order.
  - 2 An inventor is someone who designs new devices.
  - 3 Entrepreneurs are people that set up new businesses.
  - 4 Investors are people who put money into a new business.
  - 5 The Internet is a system that connects PC users and websites.
  - 6 Websites are systems which allow you to access and download information.
  - 7 Technicians are people who service and repair equipment.

### 4 Word list

digital-sonar, transmit, overboard, consist, alarm pod, hydrophone, helm unit, submerge, transducer, hull, dashboard, relay, visible, audible, via, navigate.

## 6 Procedures

### 1 Safety

- 1 1d 2f 3b 4a 5g 6e 7c
- 2 1 All fork-lift trucks should be maintained by a specialist contractor.
  - 2 Safe operating instructions should be provided for each type of fork-lift truck.
  - 3 Unqualified operators should not be allowed to drive fork-lift trucks.
  - 4 Vehicles must not be left unattended with the engine running.
  - 5 Trucks need to be parked overnight in designated areas with the brakes on.
  - 6 A battery-powered truck needs to be put on charge at the end of each working day.
  - 7 A truck must not be taken on the highway without the warehouse manager's permission.
  - 8 Levels of oil, water and antifreeze need to be checked at the start of each working day.
- 3 1 If you hear the fire alarm, stay calm.
  - 2 When the fire alarm sounds, the building must be evacuated immediately.
  - 3 Stop work at once and switch off all machines.
  - 4 Do not stop to gather your personal belongings.
  - 5 Do not use the lift.
  - 6 Do not re-enter the building until a Fire Officer gives the all-clear.

- 7 If you discover a fire, break the glass on the nearest fire alarm.
- 8 Only use a fire extinguisher if
  - you have received fire extinguisher training.
  - the fire is very small.
  - by doing this you will not place yourself in any danger.
- 9 All aisles, stairways, escape routes and fire exits must be kept clear of blockages and rubbish.
- 10 Fire doors should not be wedged open.

## 2 Emergency

- 1
  - 1 If a diver's position is not known, they must be located immediately.
  - 2 If a diver is trapped underwater, they should be freed with a knife.
  - 3 If a diver's oxygen is low, an extra air cylinder should be provided.
  - 4 If a casualty is not buoyant, their wetsuit should be inflated.
  - 5 If a casualty is slightly injured, first aid should be given in the boat.
  - 6 If a casualty is not breathing, artificial respiration must be carried out at once.
  - 7 If a casualty is seriously injured, the rescue services must be phoned.
- 2 Do get permission from the landowner before you visit a cave on their property.  
Do use underwater lines so you don't get lost.  
Do wear a helmet and a wetsuit.  
Don't wear a drysuit.  
Don't attach your air bottle to your back.  
Don't dive with a buddy.
- 3 1 theirs 2 them 3 they have taken  
4 they pass 5 theirs

## 3 Directions

- 1
  - 1 Go straight ahead at the crossroads.
  - 2 Turn left at the second set of traffic lights.
  - 3 At the roundabout, take the third exit.
  - 4 At the roundabout, go down the slip road and join the motorway.
  - 5 Come out of the station car park and turn left.
  - 6 Take the second turning on the right.
  - 7 You'll pass a garage on your left.
  - 8 Turn right at the T-junction.
- 2 Directions 1: Destination A  
Directions 2: Destination C
- 3 Remember, you'll be driving on the left. On the motorway, you'll see a slip road for Swindon Business Park. Take this slip road. When you come to the roundabout, take the second exit. That'll take you across a flyover over the motorway. At the other end of the flyover, you'll come to a T-junction. Turn left at the T-junction. Go along this road and you'll see a large Leisure Centre on your right. Just a bit further, you'll see our office on the left. Turn left here and you'll see a sign to the Visitor's Car Park.

## 4 Word list

- 1 1 first aid 2 scuba diver 3 safety issue  
4 recovery position 5 evacuation procedure  
6 artificial respiration 7 cardio-pulmonary resuscitation 8 chemical spill 9 wetsuit  
10 hand truck
- 2 1 locate 2 attended to 3 attract 4 towed  
5 recommended 6 authorised 7 be strapped  
8 overload 9 be stacked 10 be handled  
11 be inflated

## Review Unit C

### Section 1

- 1 1 generator 2 transmitter 3 carburettor  
4 protractor 5 stabiliser 6 conductor  
7 receiver 8 propeller
- 2 1g 2e 3h 4f 5a 6b 7d 8c
- 3 1 operated 2 unable 3 equipment  
4 display 5 detect 6 functions  
7 display 8 programmed 9 consists  
10 labelled with 11 controls 12 by means of

### Section 2

- 1 1 must be transported, must be locked  
2 towed, must not be used  
3 must be displayed  
4 is required, is allowed  
5 must be converted, must be inspected  
6 must be carried  
7 may be carried, must be secured  
8 is permitted, is authorised  
9 loaded, must not be left  
10 should be avoided  
11 should be carried out, are loaded, has to be refuelled, should be carried out, turned off
- 2 *Sample answer*  
Leave the port by Gate A. You'll come to a crossroads. Turn left at the crossroads. Then you'll go into an underpass under the highway. Continue past the Leisure Centre until you come to a T-junction near the sea. Turn right here. Take the first turning on the right.  
On this street there are three sets of traffic lights. Go straight ahead at the first two sets of traffic lights. Then you'll pass a big cinema on the left. At the third set of traffic lights, turn right. Take the second exit at the first roundabout, and the fourth exit at the second roundabout. After that, take the third turning on the left. If you come to the beach, you've gone too far. Do a U-turn and go back and take the first turning on the right. Stay on this road. In 35 kilometres, you'll come to the mine.

## 7 Services

### 1 Technical support

1 1i 2f 3g 4c 5e 6a 7h 8d 9b

#### 2 Sample answers

- 1 You must have checked the 'Colour' box. Try checking the 'Black' box.
- 2 You might have checked the 'Fine' box on the Print Quality menu. You could check the 'Draft' box on the menu.
- 3 There could be a loose connection. Why don't you unplug the printer and plug it in again?
- 4 The ink cartridge must be empty. You could check the level of ink remaining.
- 5 The print head nozzles may have become dirty. Try cleaning the print head nozzles.
- 6 You must have checked the 'Automatic' box on the Paper Handling menu. Why don't you check the 'Reverse' button on the menu?

### 2 Reporting to clients

- 1 1f was appointed  
2a were widened  
3g was constructed  
4h was extended  
5b were built  
6i was installed  
7c was extended  
8d was converted  
9e was built

2

Mr Tom Berghaus  
Nilsson plc  
Unit 38 West Business Park  
Swindon SN42 6BH  
21 February 2008  
Dear Mr Berghaus,  
Quotation: Extension at Swindon office  
Thank you for your letter of 31st January 2008, inviting us to prepare a quotation for the above project.  
We visited the site on 12th February 2008 and took measurements and photos. I have pleasure in enclosing our report, including outline plans and our quotation.  
Our fees are agreed on a job-by-job basis. This can be a fixed sum, or an hourly rate, or a percentage of the project cost. There is no charge for the initial visit and quotation.  
If you need to discuss the details of the report, please do not hesitate to contact us.  
Kind regards,  
Yours sincerely,  
Herbert Ritz  
Herbert Ritz  
Project Manager

## 3 Dealing with complaints

1	Date and time of call	10.45 2008/02/25
	Name of customer	Antonia Rostock
	Order number	386502/08
	Description of goods	DVD player
	Model number	2086
	Details of complaint	doesn't work
	Solution offered	replace; £5 discount off next purchase
	Customer response	accept

2 1B 2C 3F 4D 5I 6H

- 3 1 Thank you for 2 complaining about  
3 I am sorry to hear 4 Unfortunately  
5 in stock 6 However  
7 I am pleased to inform you  
8 a full refund 9 purchase price  
10 I apologise for the inconvenience  
11 Please do not hesitate  
12 Yours sincerely

### 4 Word list

- 1 1 admit 2 record 3 summarise  
4 apologise 5 offer 6 replace  
7 refund 8 deal with

## 8 Energy

### 1 Wave power

1	A	B	C	D
1 Type of motion	linear	oscillating	reciprocating	rotary
2 How it moves	moves forwards	oscillates from side to side	moves upwards and downwards, or horizontally	rotates
3 Examples of machines	rockets, jet engines	clocks, watches	pistons in petrol, diesel and steam engines; cutting machines; hand-held saw	electric motors, disk drives, fans, outboard motors, circular saws, chain saws

2 1b 2a 3a, a 4a 5a, b 6b 7b

3	Industry	Application	Water jetting pressure (psi)
	1 Automotive	Removing paint from machinery and conveyors	10,000 - 40,000
	2 Construction	Removing concrete, dirt and oil, from vehicles and mixer trucks	5,000
	3 Highway maintenance	Removing oil and mud from roads, bridges and flyovers Clearing blockages from drains	5,000 - 10,000 10,000 - 14,500

## 2 Engines

1 Intake stroke, compression stroke, combustion stroke, exhaust stroke  
1D 2A 3C 4B 5E 6G 7F 8I 9H 10J  
11L 12K 13M

2 petrol engine, electric motor

3 1a 2a 3a 4b 5a 6c

## 3 Cooling and heating

1 When a gas condenses, it becomes a liquid. When a liquid solidifies, it becomes a solid. When a solid melts, it becomes a liquid. When a liquid evaporates, it becomes a gas. So, for example, ice (a solid) melts and becomes water (a liquid). And when water boils, the water (a liquid) evaporates and becomes steam (a gas). With cooling, the steam condenses and turns to water. With freezing, the water solidifies and turns to ice.

2 1 extractor 2 operation  
3 Condensation 4 compressor  
5 Evaporation 6 Refrigeration  
7 reaction 8 decompression

3 1 removes 2 provides  
3 is reduced 4 supports  
5 compressor 6 refrigerant  
7 evaporator 8 blower  
9 evaporator 10 evaporator coils  
11 absorbs 12 return tube  
13 condensing unit 14 fan  
15 condenser coils 16 blower

## 4 Word list

1 1 internal-combustion engine 2 cam 3 intake port  
4 intake valve 5 spark plug 6 piston  
7 crankshaft 8 cylinder 9 exhaust valve

# Review Unit D

## Section 1

1 1 connected 2 unplugging 3 plugging  
4 have 5 be 6 compressing  
7 interfered 8 change 9 accessing

2 1c 2b 3e 4d 5a

3 1 have to 2 must 3 should  
4 can 5 should 6 should  
7 may 8 may 9 has to  
10 have to 11 cannot

## Section 2

1 1 piston 2 edges  
3 cylinder 4 housing  
5 inlet port 6 air and fuel mixture  
7 piston 8 mixture  
9 spark plugs 10 outlet port  
11 exhaust gases 12 chambers  
13 piston 14 drive shaft

2 1 As the rotary piston rotates, it uncovers the inlet port, which allows the air and fuel mixture to flow into the cylinder.  
2 As the piston rotates, the mixture is compressed into a small space between the piston and the cylinder wall.  
3 When the compressed fuel is ignited by the two spark plugs, the expanding gases drive the piston round on the power stroke.  
4 As the piston rotates, it uncovers the outlet port, which lets the exhaust gases escape.  
5 As the triangular piston creates three chambers, there are three ignitions for each rotation of the piston.  
6 As the rotary engine has only two moving parts, the piston and the drive shaft, higher rotation speeds are possible.

3 1 absorb 2 decompress  
3 expand 4 compressor  
5 condenser 6 evaporator  
7 expansion valve 8 fan  
9 refrigerant 10 a set of coils

# 9 Measurement

## 1 Sports data

1 1 You measure air pressure in psi with a tyre pressure gauge.  
2 A barometer is used for measuring pressure in kilopascals.  
3 You use an odometer to measure distance in kilometres.  
4 Scales are used for measuring weight in kilograms.  
5 You measure power output in Watts with a power monitor.  
6 You use a stop watch to measure time in seconds.  
7 A tachometer measures speed in kilometres per hour.  
8 An altimeter is used for measuring height above sea level in metres.  
9 You measure rate of heart beat in beats per second with a heart rate monitor.

2 1 less than 2 intervals 3 always  
4 over 5 after 6 every

3 1 renewed 2 changed 3 checked  
4 lubricated 5 inspected 6 topped up  
7 torsioned 8 renewed 9 renewed  
10 cleaned

## 2 Sensors

1 1 Compared with today, they were much less safe.  
2 They had very few. Almost none of the cars had airbags.  
3 'Marginal' means 'not very satisfactory', or in other words, 'not very good'.  
4 One-star is the lowest safety rating, so much worse than five-star. Five-star rating is the highest safety rating today.  
5 New cars are safer now, because they are stronger and have more safety features.

2		1997			Airbags	
	Model	None	Driver's	Dual	Safety rating	
1	Hydra		✓			marginal
2	Lindos	✓				poor
3	Paxos			✓		acceptable
4	Syros		✓			good

		2000			Airbags	
	Model	None	Driver's	Dual	Safety rating	
1	Lorca	✓				*
2	Pamplona			✓		***
3	Malaga			✓		****
4	Zamora		✓			**

2007	Number of small car models tested: 8
	Models with front, side and head airbags: 7
	Models with driver's airbag only: 1
	Models with 3-star safety rating: 0
	Models with 4-star safety rating: 2
	Models with 5-star safety rating: 6

- 3
- 1 bending forces
  - 2 compression forces
  - 3 tension forces
  - 4 torsion forces
  - 5 shear forces
  - 6 a heavy goods vehicle crash test
  - 7 a side impact crash test dummy
  - 8 a single direction acceleration sensor

### 3 Positioning

- 1 1a 2a 3c 4b 5a 6b 7a
- 2
- 1 where they are
  - 2 how high they are above sea level
  - 3 how fast they are flying
  - 4 how fast they are descending
  - 5 how fast they are ascending
  - 6 how far apart they are from other aircraft
  - 7 which direction they are flying in
  - 8 how far away they are from the airport

### 4 Word list

- 1
- 1 altitude, sea level, kilopascals
  - 2 latitude, longitude, transmission, satellites, orbit, altitude, nautical miles
  - 3 lidar system, approaches, tennis ball service
  - 4 detect, approach, radar system, burst, reflected, approaching

## 10 Forces

### 1 Properties

- 1
- 1 The aim of the frame test was to see whether the forks would bend when they were struck with force.
  - 2 The purpose of the tensile strength test was to find out whether the material would deform or break when it was pulled apart.

- 3 The aim of the impact-resistance test was to discover if the material would bend or break when it was hammered with force.
- 4 The objective of the compressive-strength test was to find out whether the material would crack or deform when it was compressed.
- 5 The purpose of the elasticity test was to discover whether the materials would break when they were stretched.
- 6 The aim of the plasticity test was to find out whether the material would deform or melt when it was heated to 120 degrees Celsius.
- 7 The objective of the drop test was to see whether the laptops would crack when they were dropped from a height of 60 cm.

- 2
- 1 hard 2 flexible 3 plastic 4 soft 5 rigid 6 elastic 7 compression 8 brittle 9 tension 10 tough 11 weak 12 torsional 13 tensile

### 2 Resistance

- 1
- 1 break a ble 2 in au di ble
  - 3 por ta ble 4 re sis tant
  - 5 e las tic 6 un mo vea ble
  - 7 un bend a ble 8 wa ter proof
  - 9 com bus ti ble 10 cor ro sion

2

	1 digital camera	2 diver's watch	3 home safe	4 biker's helmet
portable	✓	✓		✓
non-portable			✓	
non-combustible			✓	✓
unbreakable		✓	✓	✓
waterproof		✓		
heat-resistant			✓	
corrosion-resistant	✓	✓	✓	✓

- 3 1d 2i 3c 4e 5b 6h 7g 8a 9f
- 4
- 1 discuss danger to London of flooding + examine topic of flood defences.
  - 2 3 main causes of flooding: 1) rise in sea levels; 2) tides from north-east; 3) sinking of southeast England.
  - 3 1970s banks of River Thames raised by 2 metres. Below London 32 km of flood defences. Above London, 80 km of river banks raised.
  - 4 Thames Barrier, huge moveable flood barrier built in 1970s.
  - 5 10 moveable gates, pivoted + supported between concrete piers. When closed, barrier can withstand pressure of 9,000 tonnes.
  - 6 2001 IPCC report predicts annual rise of < 2mm. = rise of > 40 cm by end of century.
  - 7 1993–2006 sea levels rose by 3.3 mm average = rise of < 90 cm by end of century.
  - 8 list factors flooding, + examine effects + discuss methods of flood prevention.
  - 9 map of areas of London below sea level by 2100.

### 3 Results

- 1 1 causes 2 As 3 As  
 4 Since 5 therefore  
 6 As a result of 7 result 8 lead  
 9 because 10 As a result  
 11 As a result 12 then
- 2 1 Increased percentages of CO<sub>2</sub> in the atmosphere.  
 2 1850 3 Faster 4 Meltwater  
 5 It is darker  
 6 They reflect heat from the sun back into space  
 7 More  
 8 Solar, hydroelectric and geothermal energy
- 3 1 heated 2 softened 3 heated  
 4 lengthened 5 flattened 6 sharpened  
 7 softened 8 sharpen 9 sharpened  
 10 hardened 11 hardens

### 4 Word list

- 1 1 inaudible 2 unbreakable 3 non-combustible  
 4 unmoveable 5 non-portable
- 2 6 straighten 7 lighten 8 widen 9 lengthen  
 10 harden 11 fail 12 strengthen

## Review Unit E

### Section 1

1	Features	Active sonar	Passive sonar
1	Transmits and receives signals	✓	
2	Receives signals only		✓
3	Used to find out distance to target and its bearing	✓	✓
4	Used to identify a vessel		✓
5	Used for fishing and measuring the depth of the water	✓	
6	More expensive, but works at longer distances		✓
7	Noisier, and more dangerous to use in a war	✓	

### Section 2

- 1 1 deform 2 breaking point 3 withstand  
 4 yield point 5 break 6 secure  
 7 crack 8 clamp
- 2 2 The road is too narrow and has sharp corners. It should be widened and straightened.  
 3 The side walls on the bridge are not strong enough. They should be strengthened.  
 4 The approach roads on both sides are too short and steep. Therefore they should be lengthened.
- 3 1 The old cables were taken out, and new wiring was installed last year, and as a result the number of electrical accidents has fallen to zero.  
 2 Concrete horizontal decks were placed under the floors five years ago, and so the building

resisted yesterday's earthquake at 8.4 on the Richter scale.

- 3 All our diesel engines were replaced two years ago with hydrogen engines. As a result, carbon emissions in the city have gone down by over 50%.
- 4 The frame of the new bike has failed the compression and rigidity tests. Therefore, we have decided to use titanium instead of aluminium.
- 5 Since the captain of the damaged sailing boat had a GPS system on board, the air-sea rescue team were able to locate its position very quickly.
- 6 As the crash-testing of the new model was 100% successful, the company will start to manufacture the sports car early next year.

4	deform	destructive	elastic	emission	flexibility	
	indicate	isolate	isolation	objective	resist	
	rigid	rigidity	specify	tension	torsion	withstand

## 11 Design

### 1 Working robots

- 1 1 mechanical 2 dangerous 3 repeated  
 4 electric 5 compressed 6 mobile  
 7 remote 8 specific 9 different

- 2 1c 2a 3f 4e 5b 6d

### 2 Eco-friendly planes

- 1 1 wing 2 pressure 3 lift 4 gravity  
 5 wing 6 lift 7 friction 8 Drag 9 engines  
 10 thrust 11 engines 12 thrust 13 weight

2	Comparative survey results	business jet	airline	turboprop taxi
	Point-to-point travel (near client's base)	NO	NO	YES
	Reasonable prices	NO	YES	YES
	Need long runway	YES	YES	NO
	Delays when using major airports	YES	YES	NO

### 3 Free-flying sails

- 1 1h 2b 3g 4j 5c 6e 7a 8i 9f 10d
- 2 1 Aim: Examine difference between monohull ferries and multi-hull ferries.  
 2 Question: How old is the catamaran design? First used by fishermen in southern India, 1,500 years ago. Later, design spread through southeast Asia.  
 3 Two hulls, joined together by a frame. Sporting/commercial catamarans built for past 100 years, e.g. large ferries: two hulls, each powered by one engine.  
 4 Catamaran design. Lighter and faster. Their stability is better. Go fastest when waves are small.  
 5 Dimensions: 126 metres long; 40 metres wide; depth of 4.8 metres in the water.



- 6 Load: HSS 1500. 1500 passengers and 375 cars. HSS 900. 900 passengers and 200 cars.
- 7 Performance data: HSS 1500: in-service speed 75 kph, 110 kph max. HSS 900 is slower.
- 8 Problem: Material used for the hulls, a type of aluminium alloy.
- 9 Disadvantages: Build cost. More expensive to build a multi-hull ferry than a monohull ferry. Also running costs.
- 10 Graph: Compares fuel costs. More expensive to run one multi-hull ferry than seven mono-hull ferries.  
Fuel costs certain to rise, not fall, in future.

- 3 1 components 2 drawback 3 data 4 aim  
5 client 6 operation 7 dimensions 8 issue  
9 signpost 10 brief

#### 4 Word list

- 1 1 conduct 2 improved 3 reduce 4 Untie  
5 maximise 6 emit 7 consume 8 mention

## 12 Innovation

### 1 Zero emission

- 1 1 **Need** 2 **Problems** 3 **Solution**  
4 **Technology** 5 **Advantages** 6 **Components**  
1 reduced 2 consume 3 used  
4 combine 5 provides 6 delivers  
7 based 8 emit 9 run  
10 recharges 11 positioned 12 located  
13 mounted 14 produced 15 recharge  
16 power
- 2 1 battery 2 inverter/converter  
3 electric motor 4 drive wheels  
5 reduction gear 6 engine  
7 power split device 8 generator

### 2 Technological change

- 1 1 Tools: abacus, compass, wedge, spectacles.  
2 Simple machines: crank and rod, pulley and belt.  
3 Heavy machine tools: crane, hydraulic jack.  
4 Self-running machines: boiler, windmill, robot, wind turbine.
- 2 1 robot 2 windmill 3 boiler 4 crank  
and rod 5 spectacles 6 crane 7 abacus  
8 compass 9 wind turbine 10 pulley and belt  
11 wedge 12 hydraulic jack

### 3 Sample answer

The earliest waterwheel was made in Greece 2,000 years ago. It was made of wood. It consisted of a horizontal wheel, which rotated when a stream of water hit the paddles. The force of the water made the wheel and the attached axle rotate. The axle was attached to the waterwheel at one end and to a circular millstone at the other. The millstone rotated to grind corn into flour. Later, vertical waterwheels were used. These could be built to a greater size, with greater power.

### 3 Vehicle safety

- 1 These questions are not asked: 2, 10
- 2 1 Tyre Pressure Monitoring System (TPMS).  
3 It monitors the pressure and temperature of tyres.  
4 To prevent road traffic accidents, caused by tyre failure. Because about 20 percent of cars have tyres that are under-inflated.  
5 It uses electronic sensor technology, and wireless data display.  
6 A sensor.  
7 The sensor is placed directly onto the wheel inside the tyre.  
8 The system consists of four valve-mounted tyre pressure sensors, and one central radio frequency receiving unit, powered by batteries. The information is transmitted by wireless to the display in front of the driver, which shows the pressure and temperature data.  
9 It reduces tyre failure and resulting accidents. It helps reduce tyre wear. It helps reduce fuel consumption.
- 3 1 contain 2 allow 3 ensure 4 activate  
5 send 6 provide 7 prevent 8 report  
9 detect 10 give

#### 4 Word list

- 1 1 accelerate 2 release 3 mass-produced  
4 lightweight 5 output 6 gain  
7 zero-emission

## Review Unit F

### Section 1

- 1 1 advantages 2 strength 3 drawbacks  
4 disadvantages 5 weakness 6 would  
7 suggest 8 could 9 suggest 10 should  
11 could 12 improved
- 2 1f 2b 3h 4c 5i 6a 7e 8d 9g

### Section 2

- 1 1 When did people first start to investigate laser drilling?  
2 What kind of lasers did they use?  
3 What effect does the laser beam have?  
4 How does it split the rock?  
5 Is splitting more efficient than melting?  
6 Is more energy required to split different kinds of rocks?  
7 What are you researching now?
- 2 A/4/b; B/3/a; C/2/c; D/1/d
- 3 a blowout preventer which was developed a large valve that is fitted a device that is designed this valve, which is usually operated features which were invented components that are designed cutters that are fitted intervals which are agreed

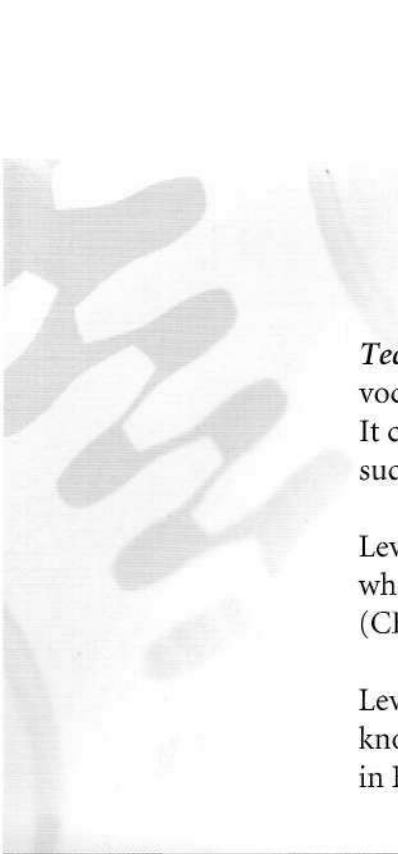

*Technical English* is a two-level course for students in technical or vocational education, and for company employees in training at work. It covers the core language and skills that students need to communicate successfully in all technical and industrial specialisations.

Level 1 is for students with a basic knowledge of general English who now require an elementary course in English for specific purposes. (CEF level A1)

Level 2 is for students who have completed Level 1, or have an elementary knowledge of general English, and now require a pre-intermediate course in English for specific purposes. (CEF level A2)

- Technical concepts are clearly presented using motivating texts and clear illustrations
- Topics reflect the latest developments in technology and are relevant to students' needs
- The course uses core language common to a range of specialisations
- Grammar is regularly practised and there is a comprehensive grammar summary section
- The Companion Website has further industry-specific material to support the Course Book and the Workbook

#### **Components**

- Course Book
- Course Book Audio CD
- Workbook with Audio CD
- Teacher's Book with Test Master CD-ROM
- Companion Website: [www.pearsonlongman.com/technicalenglish](http://www.pearsonlongman.com/technicalenglish)

